

FAUSTO MİMARİ SİSTEMLER

GYT130 GİYOTİN SİSTEM SERİSİ

GYT130 GUILLOTINE SYSTEM SERIES

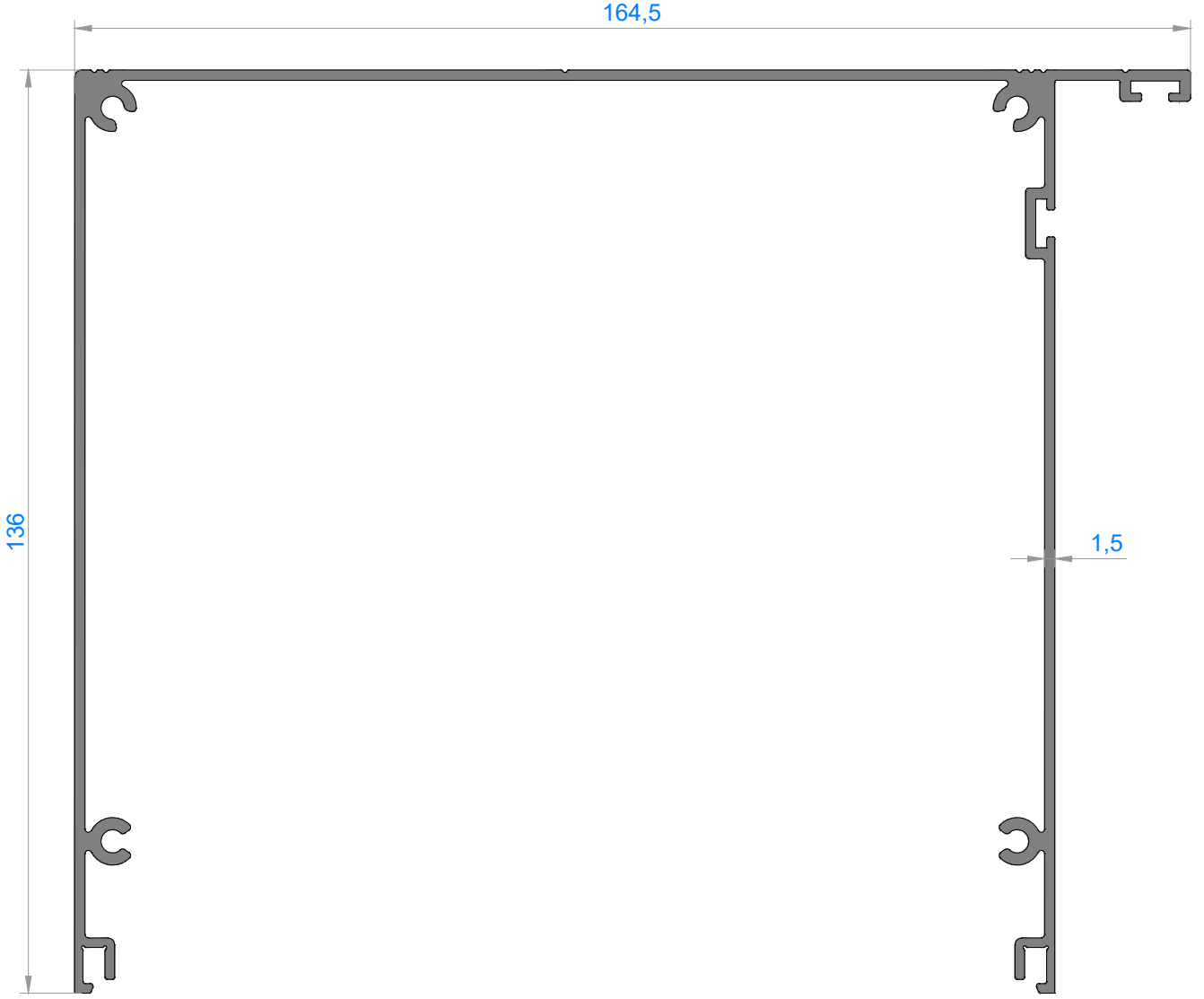

Sistem Kodu 5600
Ağırlık (kg/mt) 2,209

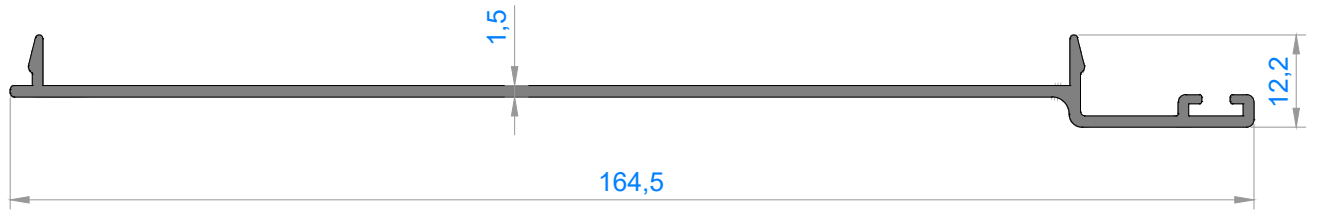

Sistem Kodu 5600
Ağırlık (kg/mt) 0,769

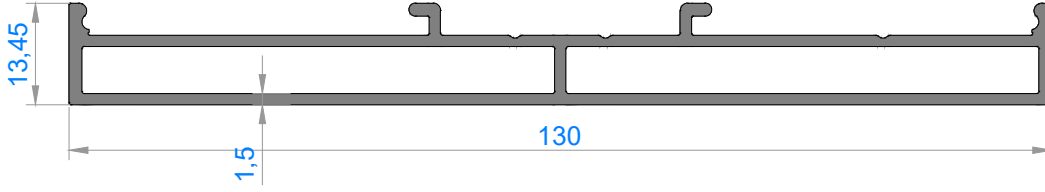

Sistem Kodu 5602

Ağırlık (kg/mt) 1,242

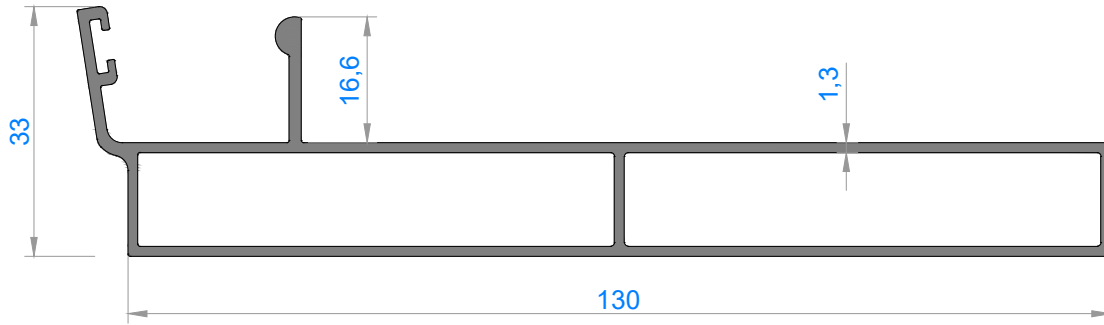

Sistem Kodu 5606

Ağırlık (kg/mt) 1,255

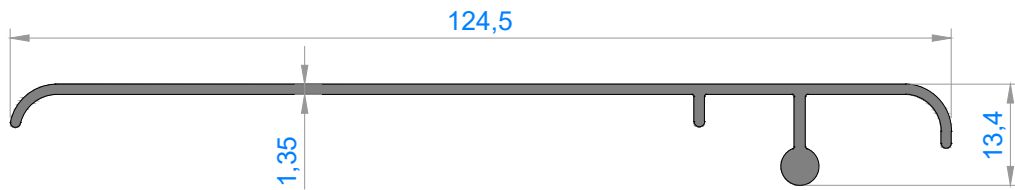

Sistem Kodu 5607

Ağırlık (kg/mt) 0,577

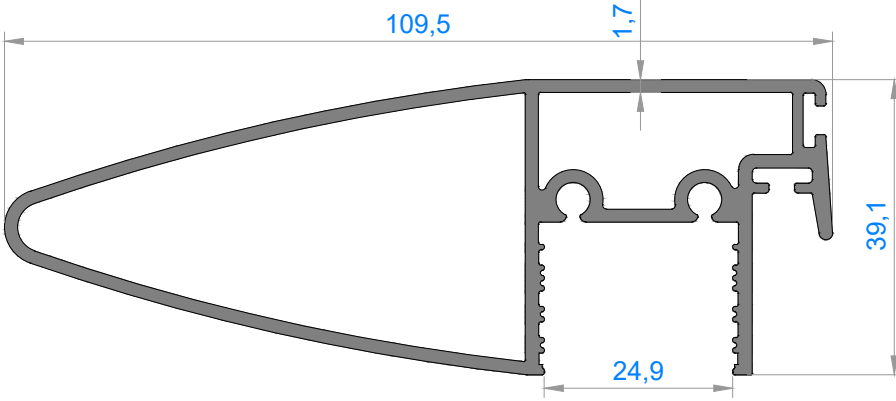

Sistem Kodu **5613**

Ağırlık (kg/mt) **1,587**

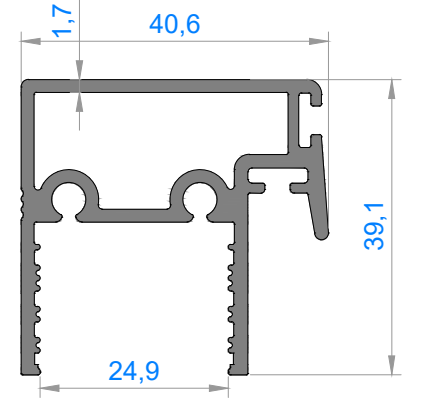

Sistem Kodu **5609**

Ağırlık (kg/mt) **0,920**

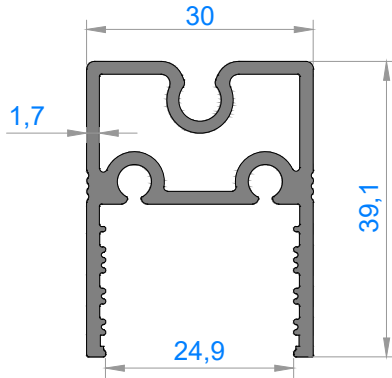

Sistem Kodu **5610**

Ağırlık (kg/mt) **0,800**

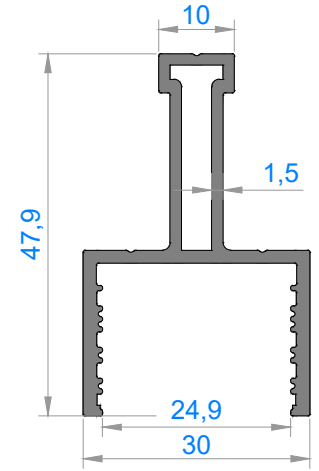

Sistem Kodu **5611**

Ağırlık (kg/mt) **0,617**

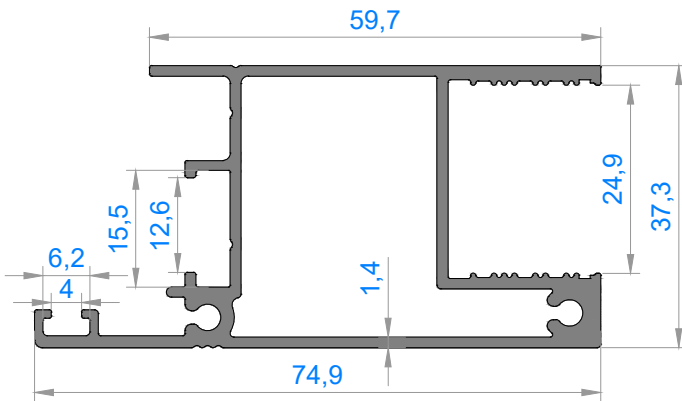

Sistem Kodu **5608**

Ağırlık (kg/mt) **1,112**

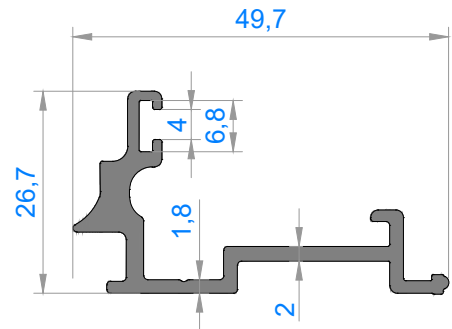

Sistem Kodu **5612**

Ağırlık (kg/mt) **0,558**

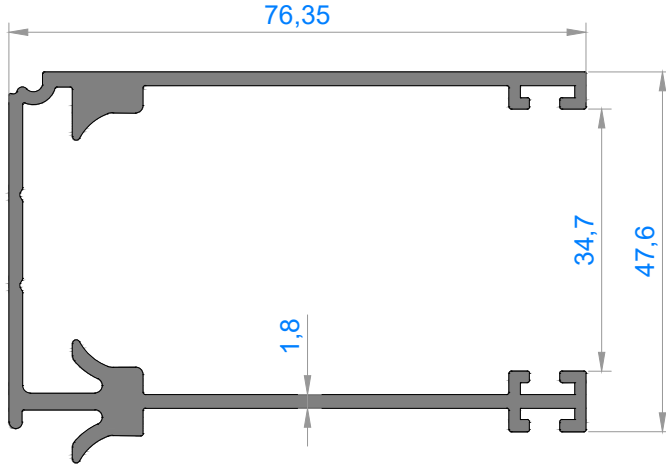

Sistem Kodu **5603**
Ağırlık (kg/mt) **1,356**

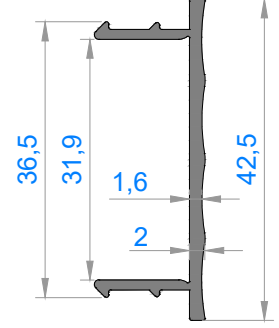

Sistem Kodu **5604**
Ağırlık (kg/mt) **0,298**

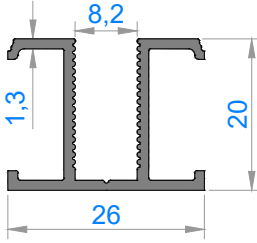

Sistem Kodu **5605**
Ağırlık (kg/mt) **0,309**

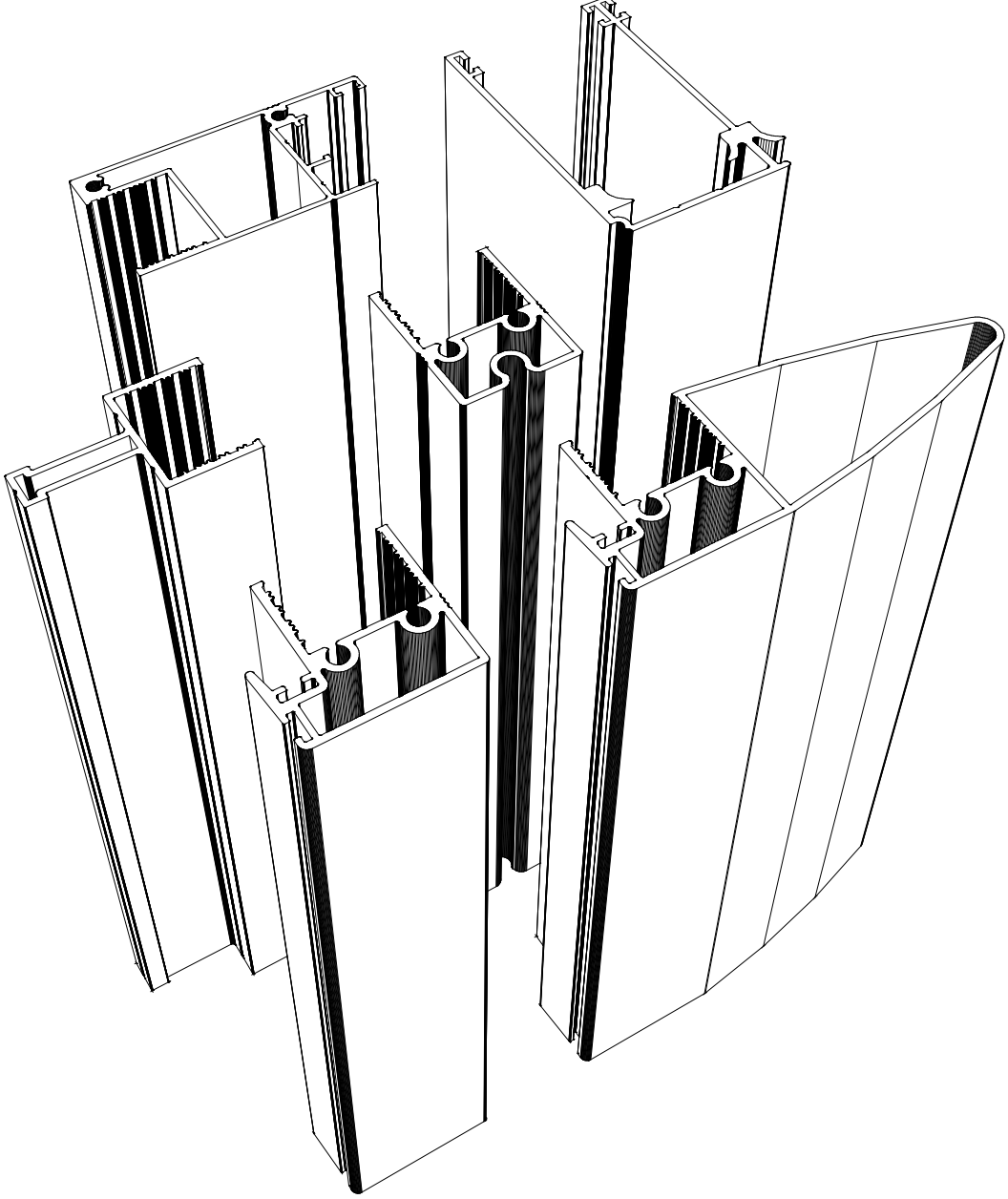
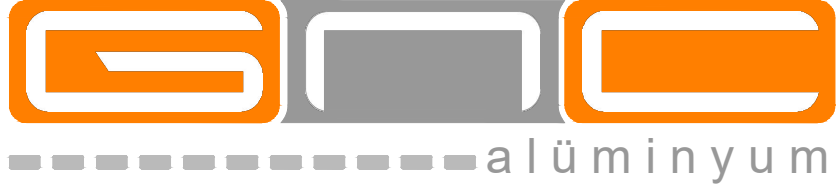

FAUSTO MİMARİ SİSTEMLER

SİSTEM DETAYLARI
SYSTEMS DETAILS

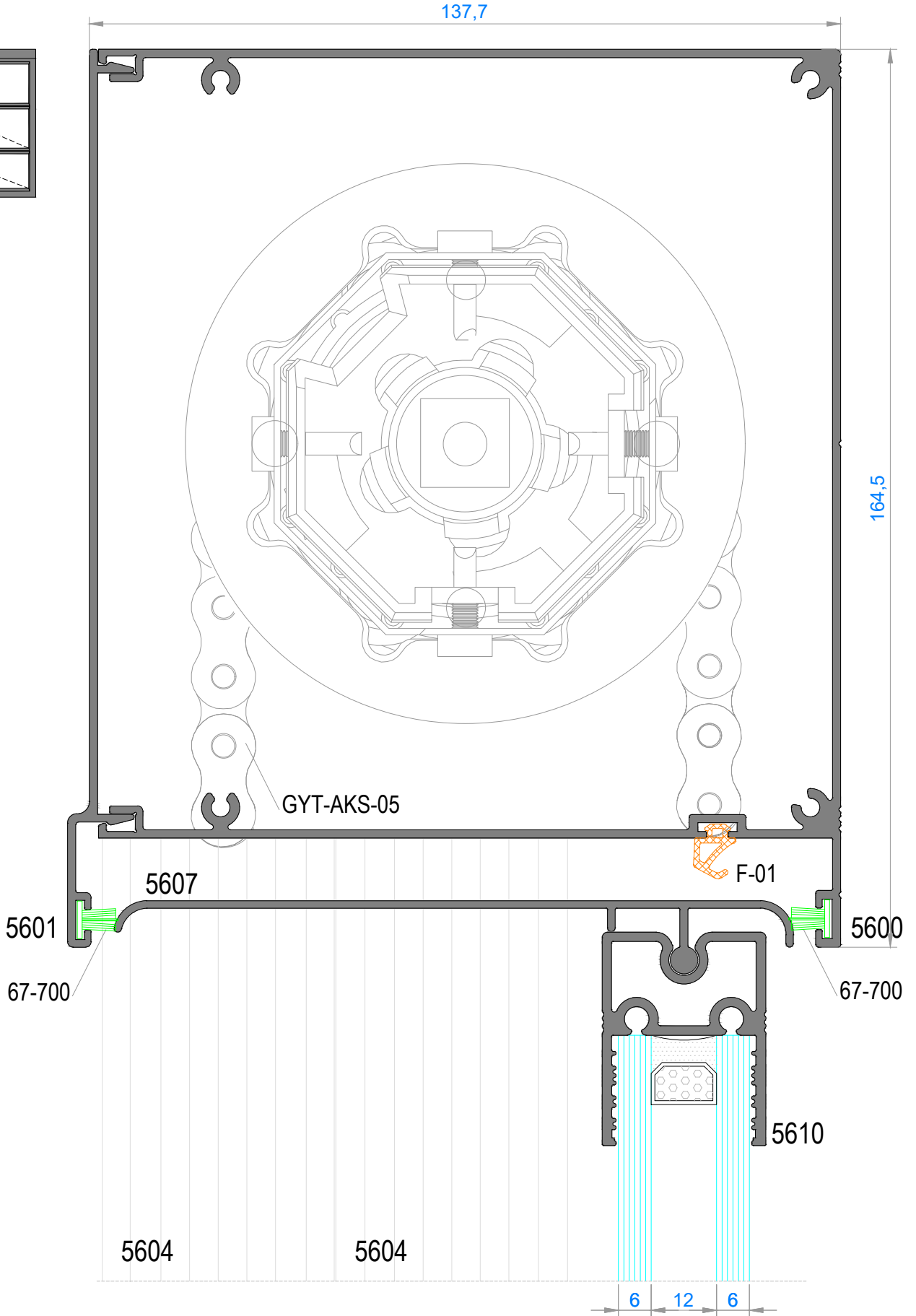
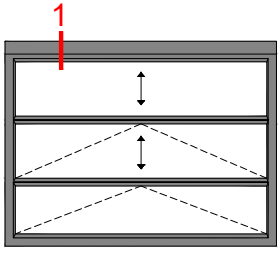

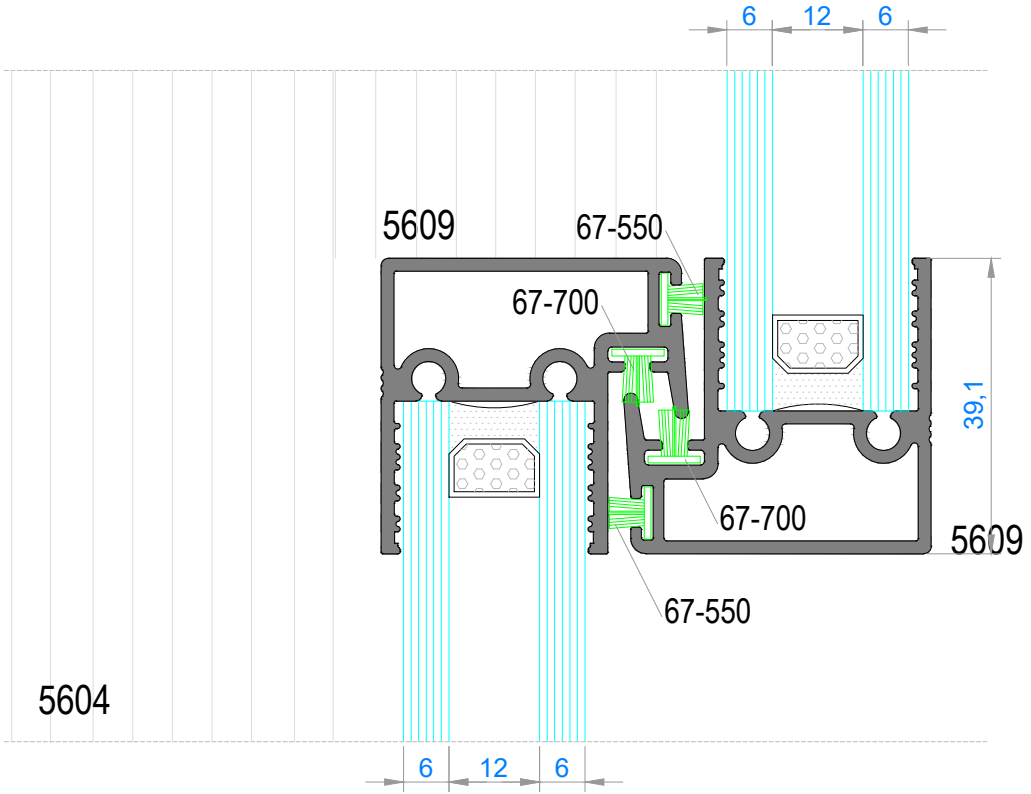
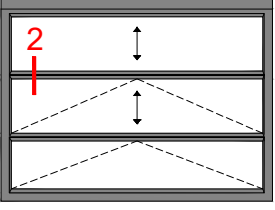

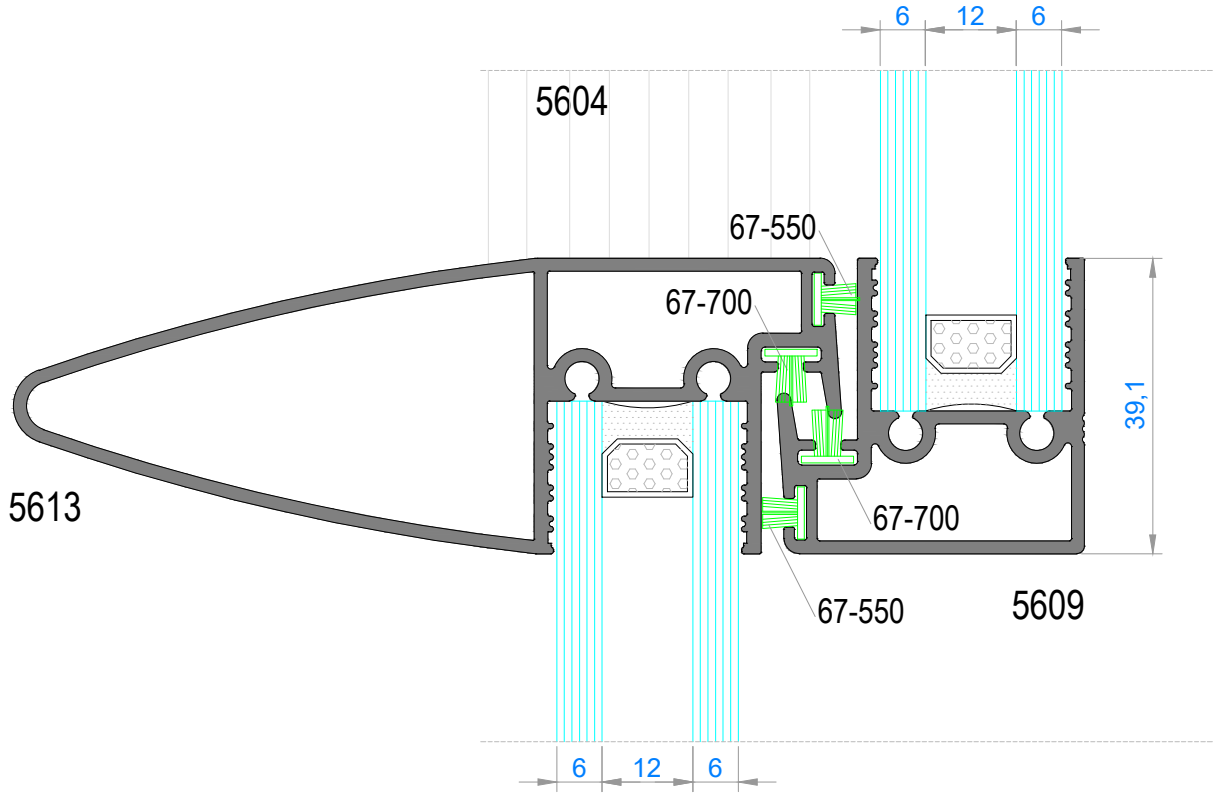
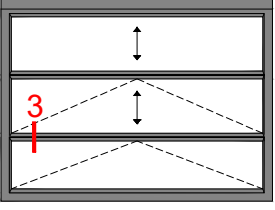

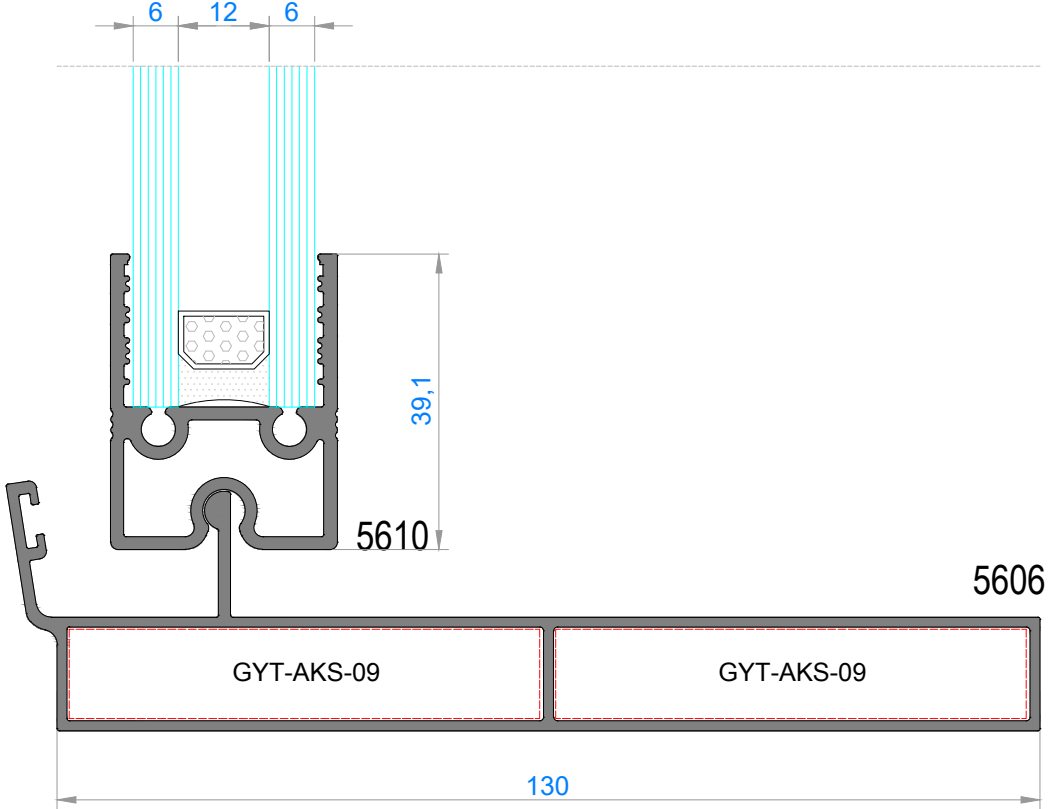
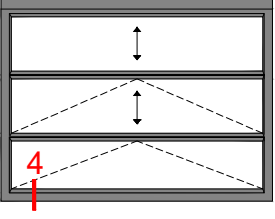

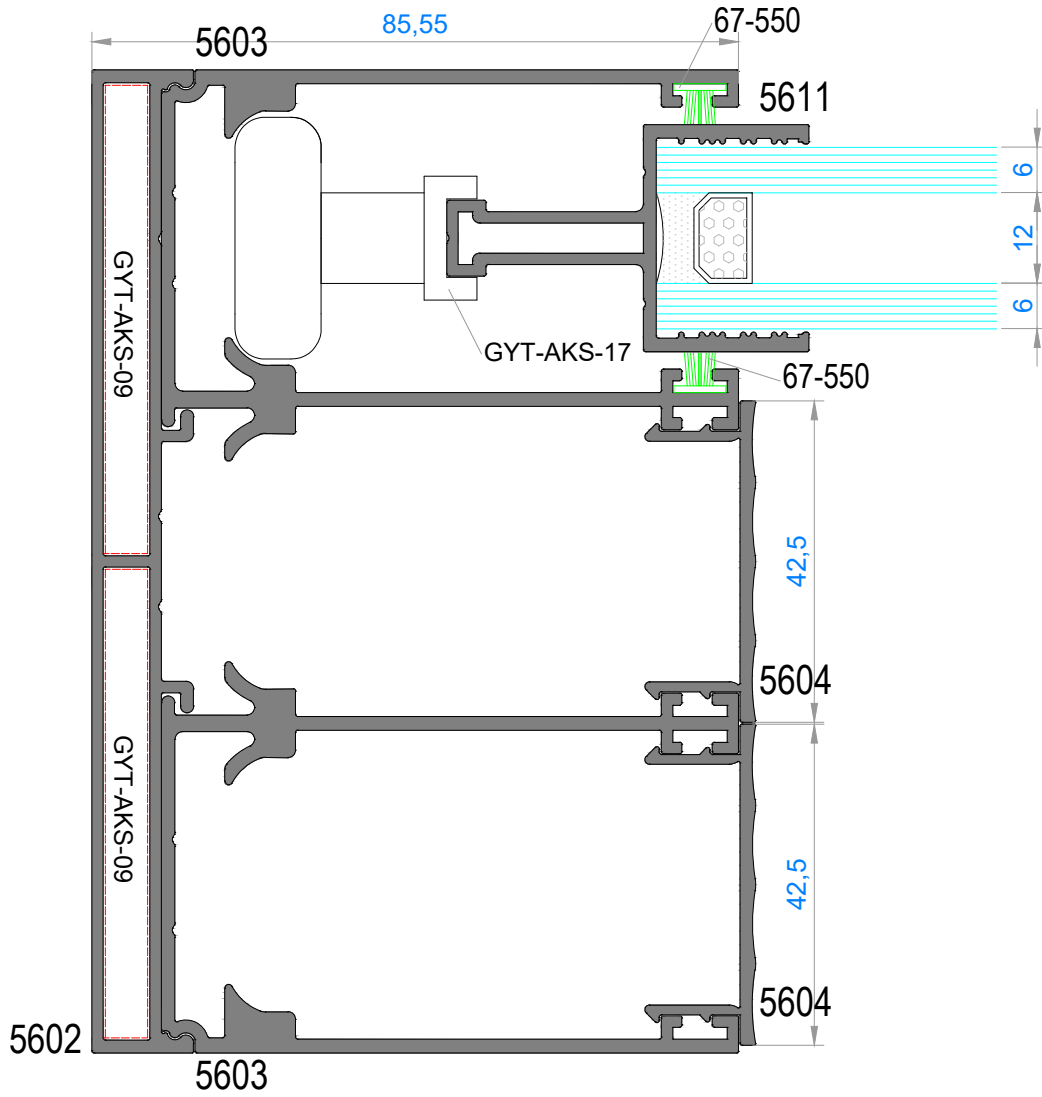
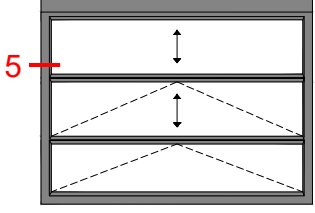

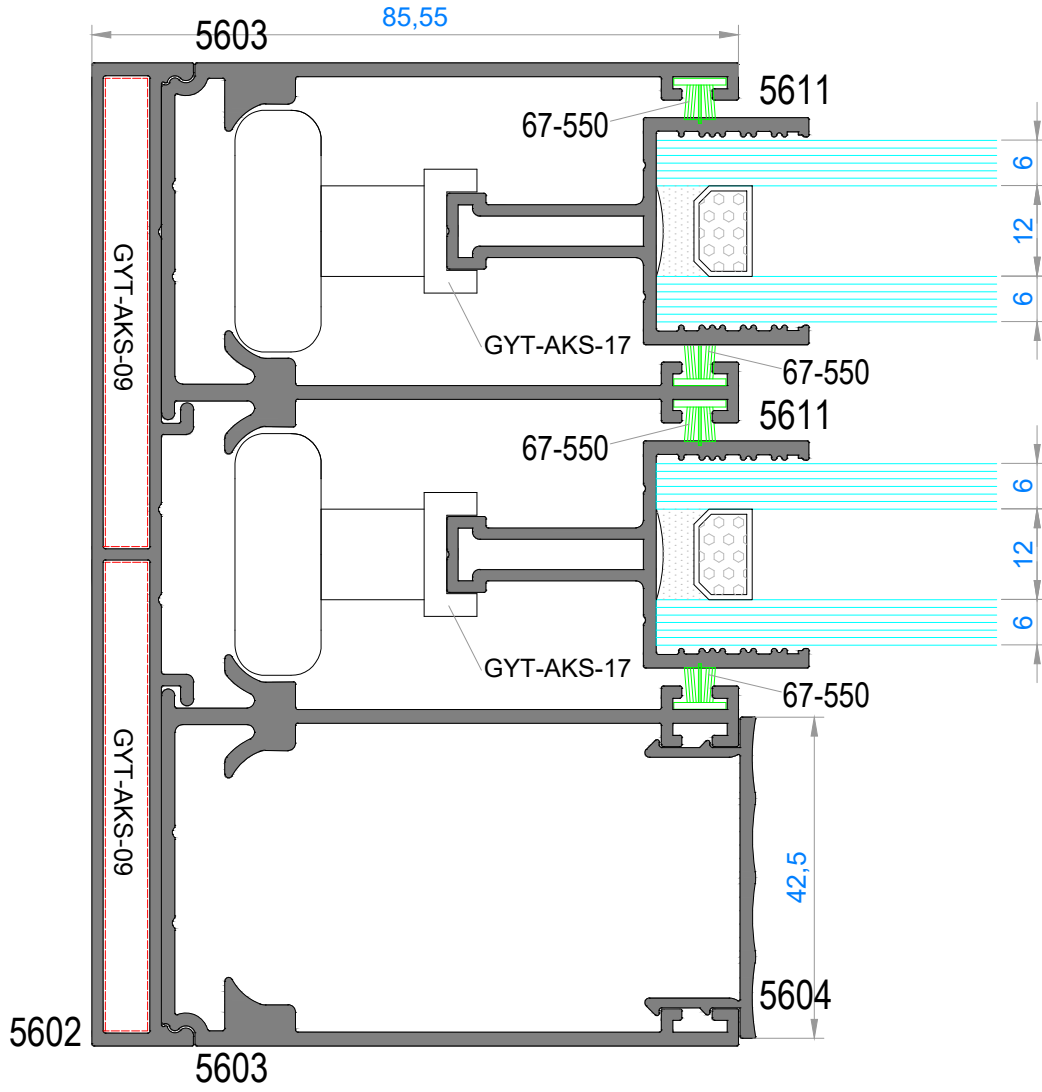
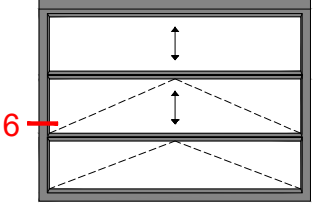

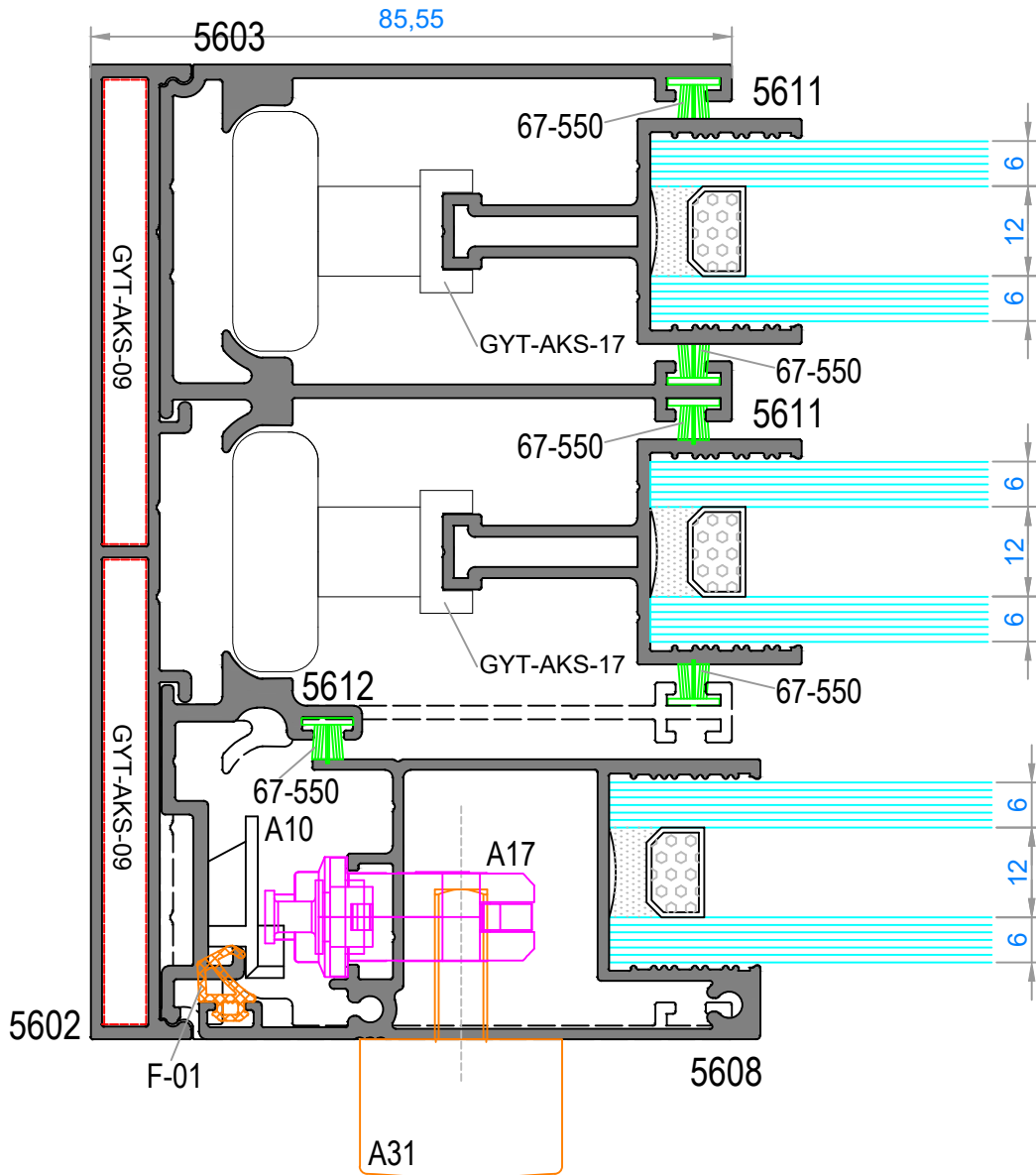
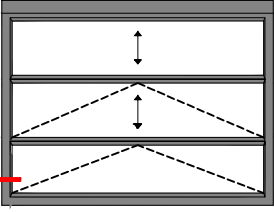

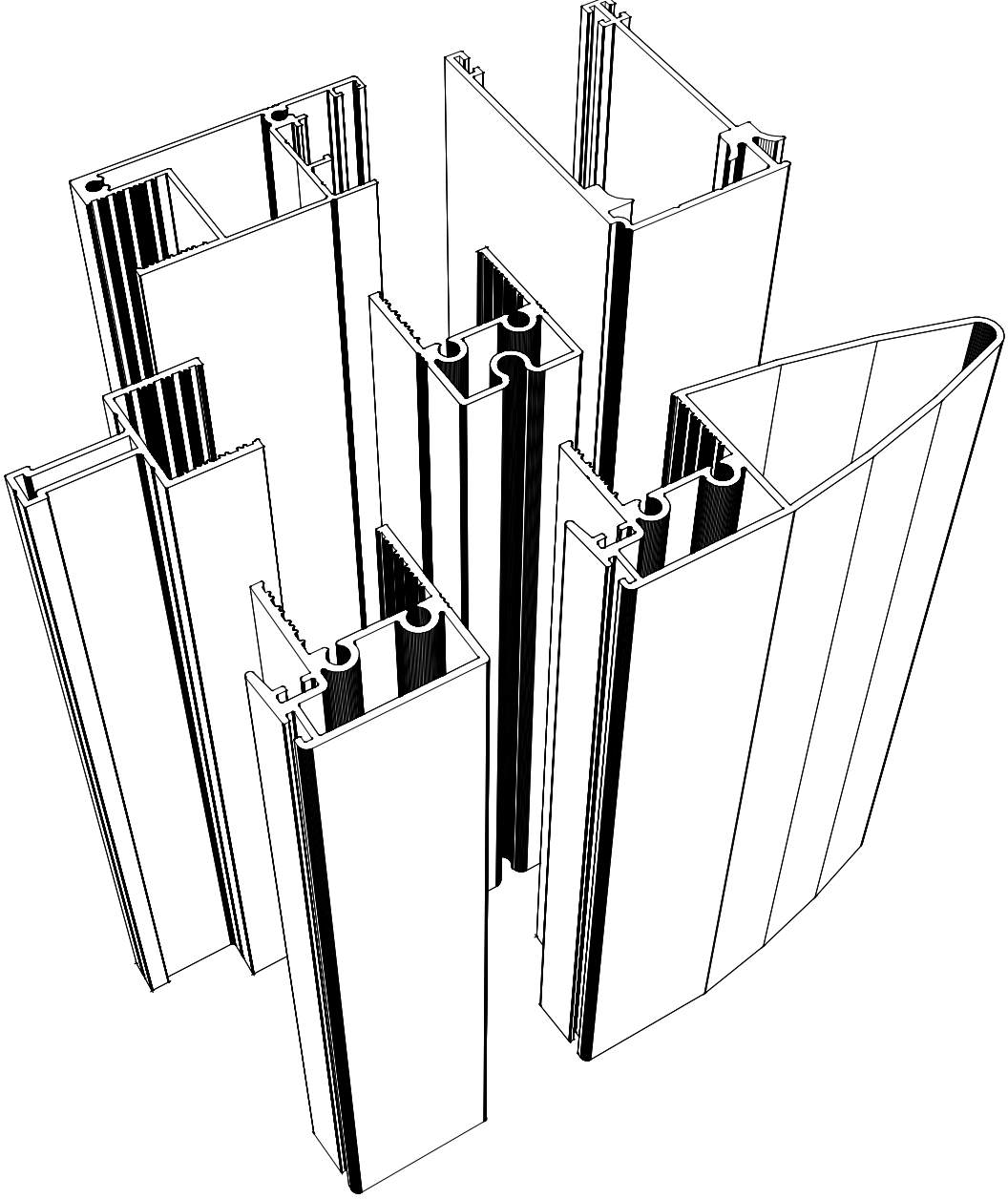
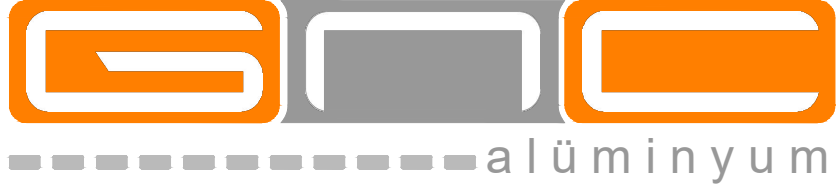







FAUSTO MİMARİ SİSTEMLER

AKSESUARLAR

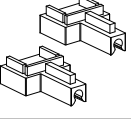
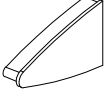
ACCESSORIES

AKSESUAR RESMİ	AKSESUAR KODU	MALZEME	MALZEME TANIMI	AMBALAJ	BİRİM FİYAT
	GYT-AKS-01	INOX	MOTOR KUTUSU YAN KAPAK	2 ADT	
	GYT-AKS-02	INOX	70'LİK BORU	MT	
	GYT-AKS-03	PVC	BORU BAŞI	1 ADT	
	GYT-AKS-05	INOX	ZİNCİR (3m)	2 ADT	
	GYT-AKS-06	INOX	DİŞLİ	2 ADT	
	GYT-AKS-07		MOSEL SEL-70 120Nm RADYO ALICILI GİYOTİN MOTORU	1 ADT	
	GYT-AKS-08		DC 104 MOSEL VERİCİ KUMANDA	1 ADT	
	GYT-AKS-09	PVC	ALT TABLA SOL&SAĞ KÖŞE BİRLEŞTİRME	1 TKM	
	GYT-AKS-10	PVC	AÇILIR KANAT ALT SOL&SAĞ KÖŞE	1 TKM	
	GYT-AKS-11	PVC	AÇILIR KANAT ÜST SOL&SAĞ KAPAK	1 TKM	
	GYT-AKS-12	PVC	"U" PROFİL SOL&SAĞ KAPAK	1 TKM	
	GYT-AKS-13	PVC	ÜST KANAT KAPAK	2 ADT	
	GYT-AKS-14	PVC	KENET PROFİL SOL&SAĞ KAPAK	3 TKM	

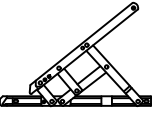
NOT: Profil ağırlıkları teoriktir, üretim sonrası ağırlıklar geçerlidir.

AKSESUAR RESMİ	AKSESUAR KODU	MALZEME	MALZEME TANIMI	AMBALAJ	BİRİM FİYAT
	GYT-AKS-15	PVC	ALT KANAT KÖŞE	2 ADT	
	GYT-AKS-16	PVC	TAKVİYELİ KENET KAPAK (5613 NO'LU PROFİL KULLANILIRSA)	2 ADT	
	GYT-AKS-17	PVC	SARSINTI ÖNLEYİCİ TEKER	6 ADT	
	A17	INOX	İSPANYOLET MEKANİZMASI 400-600/15 600-800/15	2 ADT	
	A10	INOX	İSPANYOLET KARŞILIĞI	4 ADT	
	A31		AKUSTİK KOL	2 ADT	
	CA-01	INOX	MAKAS	2 ADT	
	KIL FİTİL	NAYLON	$\frac{67}{550}$ - $\frac{67}{700}$ KIL FİTİL	4X300MT/KG	
	F-01	EPDM	BİNE FİTİLİ	285 MT / 12 KG	

NOT: Profil ağırlıkları teoriktir, üretim sonrası ağırlıklar geçerlidir.