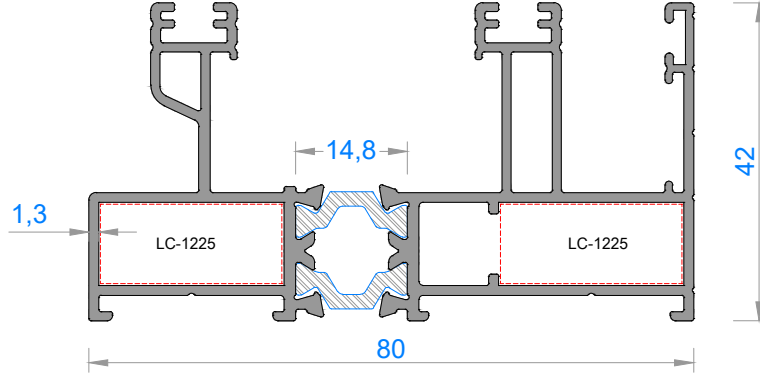

FAUSTO MİMARİ SİSTEMLER

32ST YALITIMLI SÜRME SİSTEM SERİSİ

32ST INSULATED SLIDE SYSTEM SERIES

**Sistem Kodu 7600-7601**

Ağırlık (kg/mt) 1,485

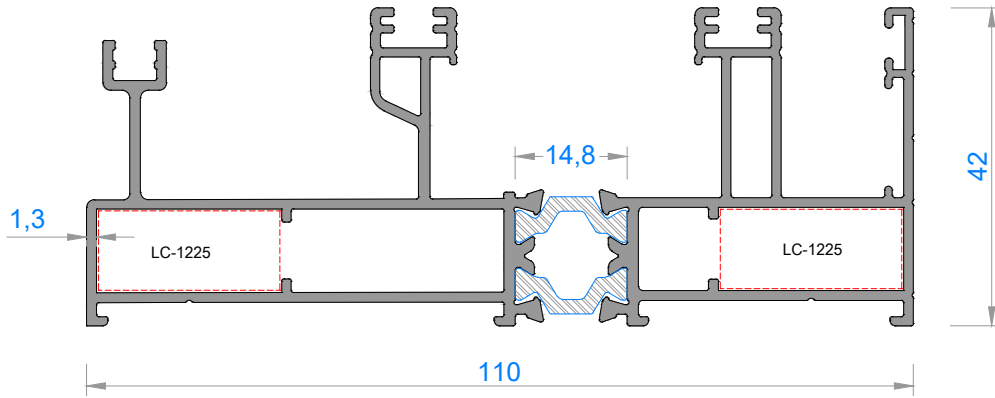
Statik Jx (cm⁴) 7,98Statik Jy (cm⁴) 32,13**Sistem Kodu 7602-7601**

Ağırlık (kg/mt) 1,824

Statik Jx (cm⁴) 9,60Statik Jy (cm⁴) 72,80

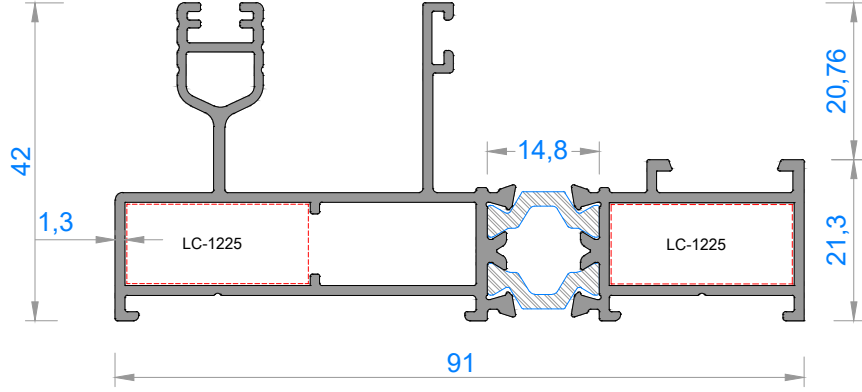

Sistem Kodu	7603-7604
Ağırlık (kg/mt)	1,395
Statik Jx (cm ⁴)	5,50
Statik Jy (cm ⁴)	36,30

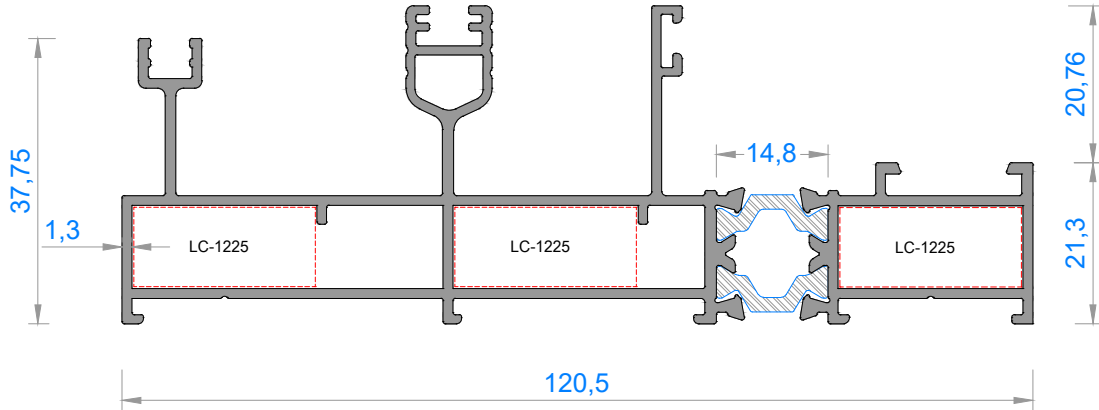

Sistem Kodu	7605-7604
Ağırlık (kg/mt)	1,786
Statik Jx (cm ⁴)	7,45
Statik Jy (cm ⁴)	78,6

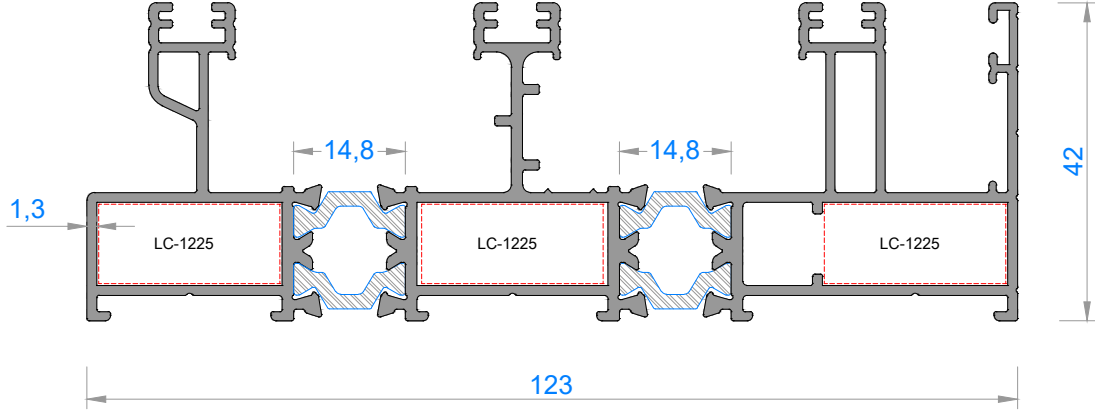
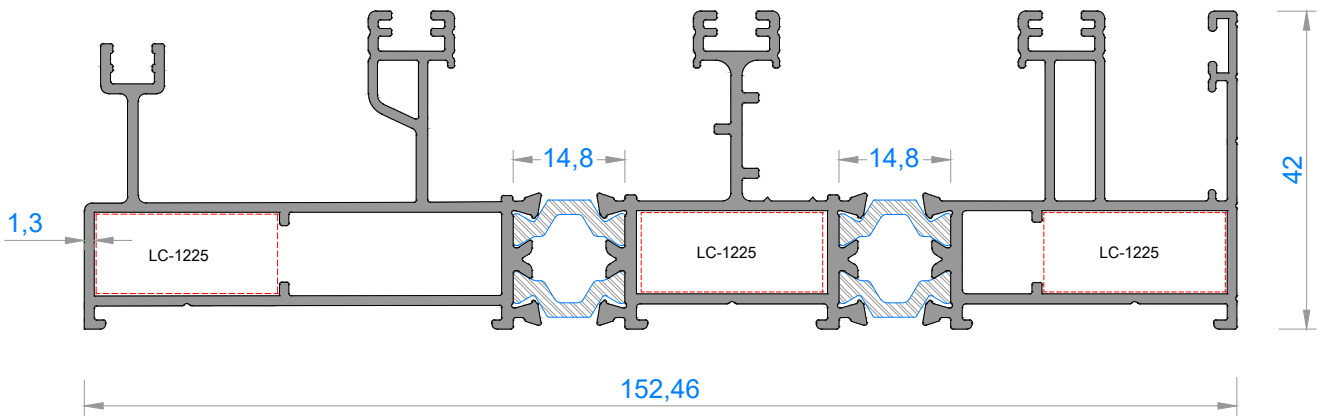

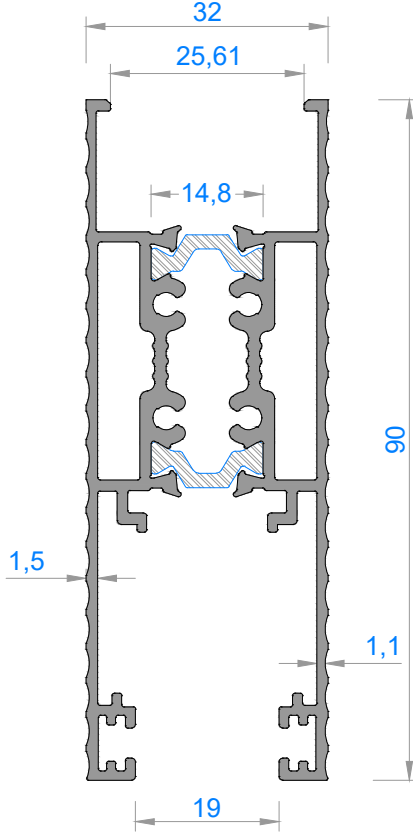
Sistem Kodu 7600-7606-7601
Ağırlık (kg/mt) 2,262
Statik Jx (cm⁴) 11,68
Statik Jy (cm⁴) 107,25

Sistem Kodu 7602-7606-7601
Ağırlık (kg/mt) 2,601
Statik Jx (cm⁴) 13,28
Statik Jy (cm⁴) 185,05

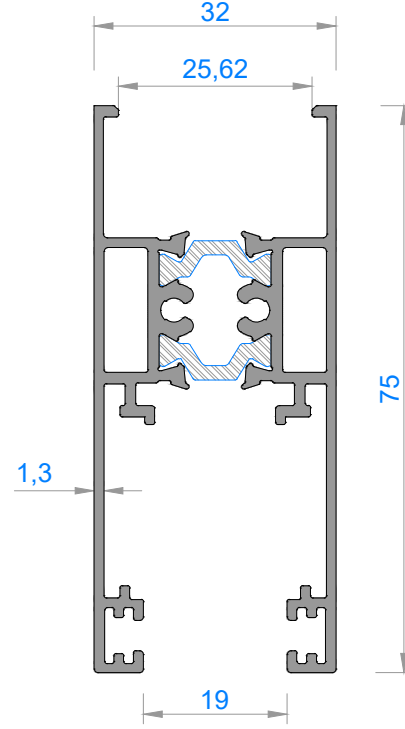
Sistem Kodu 7607-7607

Ağırlık (kg/mt)	1,581
Statik Jx (cm ⁴)	27,82
Statik Jy (cm ⁴)	7,43

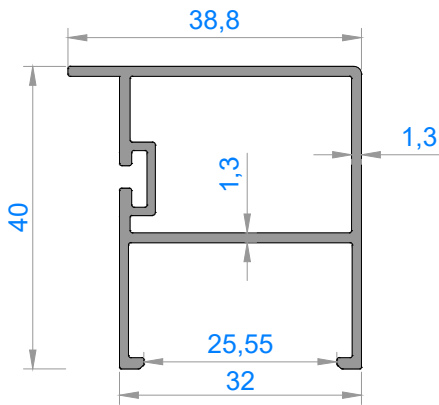
Sistem Kodu 7608-7608

Ağırlık (kg/mt)	1,272
Statik Jx (cm ⁴)	16,10
Statik Jy (cm ⁴)	6,52

Sistem Kodu 7622

Ağırlık (kg/mt)	0,558
Statik Jx (cm ⁴)	3,66
Statik Jy (cm ⁴)	2,92

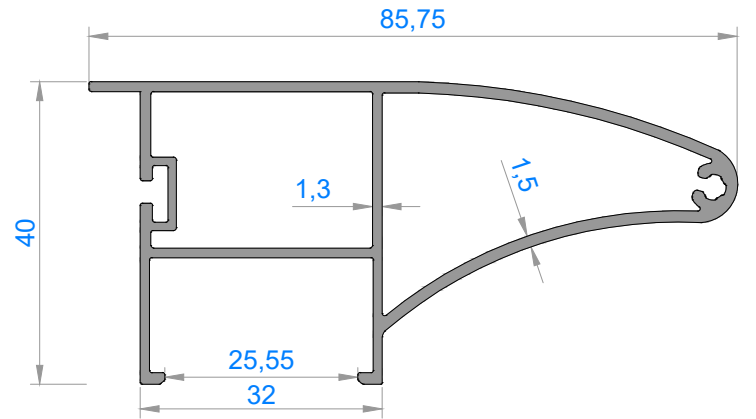
Sistem Kodu 7623

Ağırlık (kg/mt)	1,005
Statik Jx (cm ⁴)	23,83
Statik Jy (cm ⁴)	4,50

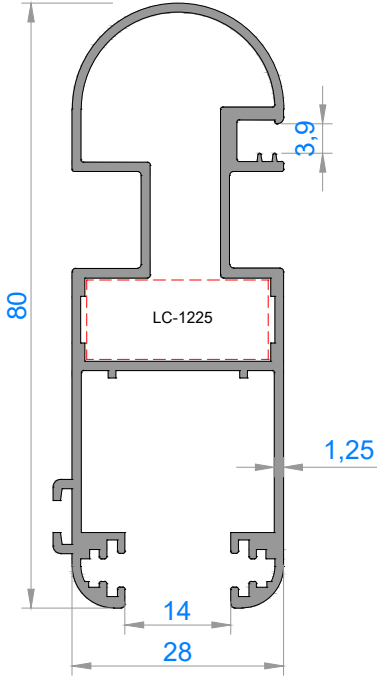

Sistem Kodu	7611
Ağırlık (kg/mt)	0,992
Statik J_x (cm ⁴)	20,40
Statik J_y (cm ⁴)	4,10

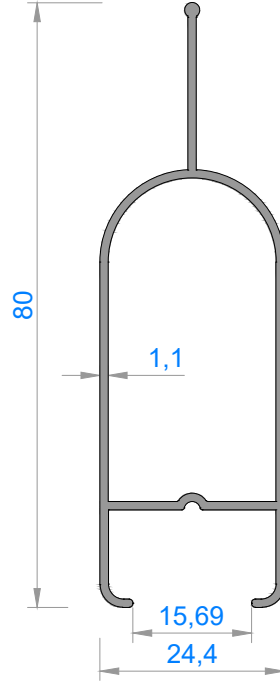

Sistem Kodu	7612*
Ağırlık (kg/mt)	0,532
Statik J_x (cm ⁴)	9,38
Statik J_y (cm ⁴)	1,77

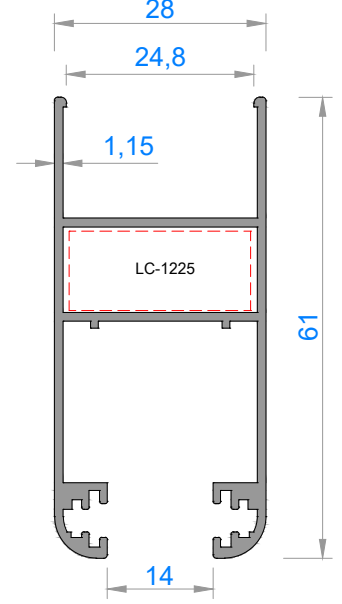

Sistem Kodu	4906
Ağırlık (kg/mt)	0,679
Statik J_x (cm ⁴)	7,80
Statik J_y (cm ⁴)	3,33

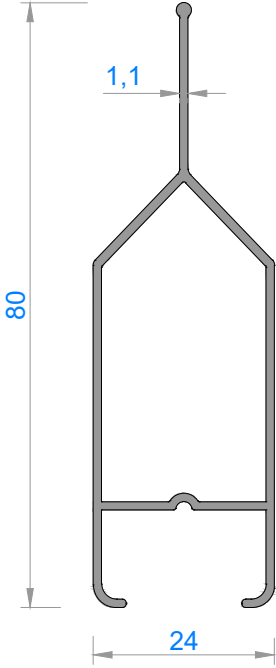

Sistem Kodu	7613
Ağırlık (kg/mt)	0,528
Statik J_x (cm ⁴)	9,07
Statik J_y (cm ⁴)	1,16

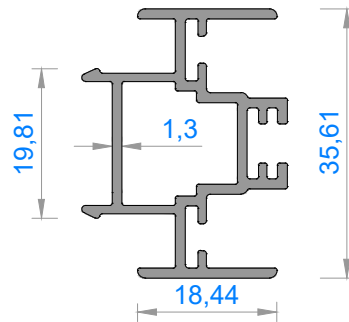

Sistem Kodu	7614
Ağırlık (kg/mt)	0,529
Statik J_x (cm ⁴)	2,35
Statik J_y (cm ⁴)	0,96

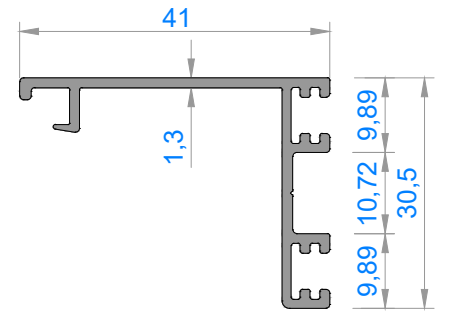

Sistem Kodu	7615
Ağırlık (kg/mt)	0,363
Statik J_x (cm ⁴)	2,84
Statik J_y (cm ⁴)	0,75

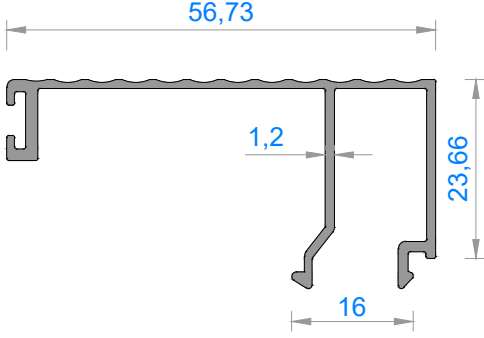

Sistem Kodu	7616
Ağırlık (kg/mt)	0,414
Statik <i>Static</i> Jx (cm ⁴)	0,92
Jy (cm ⁴)	6,30

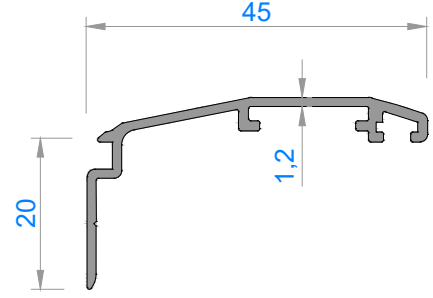

Sistem Kodu	7617
Ağırlık (kg/mt)	0,273
Statik <i>Static</i> Jx (cm ⁴)	2,58
Jy (cm ⁴)	0,21

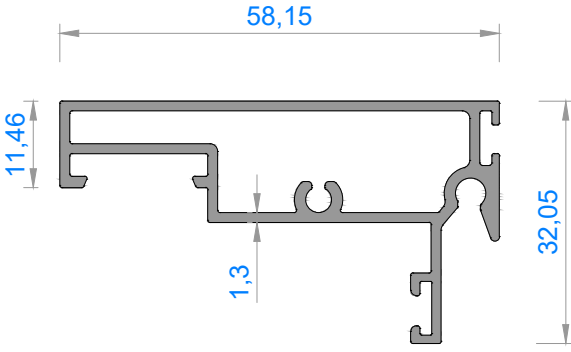

Sistem Kodu	7618
Ağırlık (kg/mt)	0,709
Statik <i>Static</i> Jx (cm ⁴)	9,23
Jy (cm ⁴)	1,40

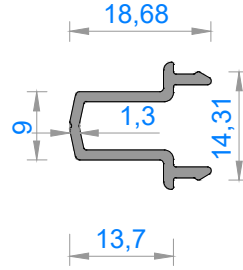

Sistem Kodu	4915
Ağırlık (kg/mt)	0,176

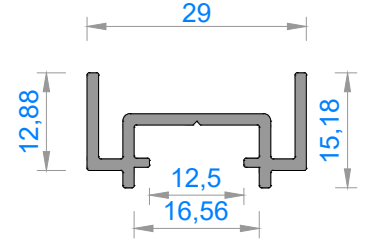

Sistem Kodu	7619
Ağırlık (kg/mt)	0,289

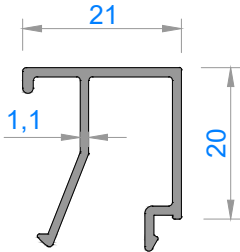

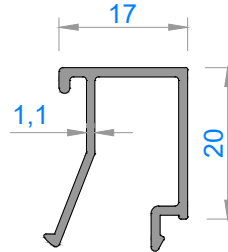

Sistem Kodu	7620
Ağırlık (kg/mt)	0,238

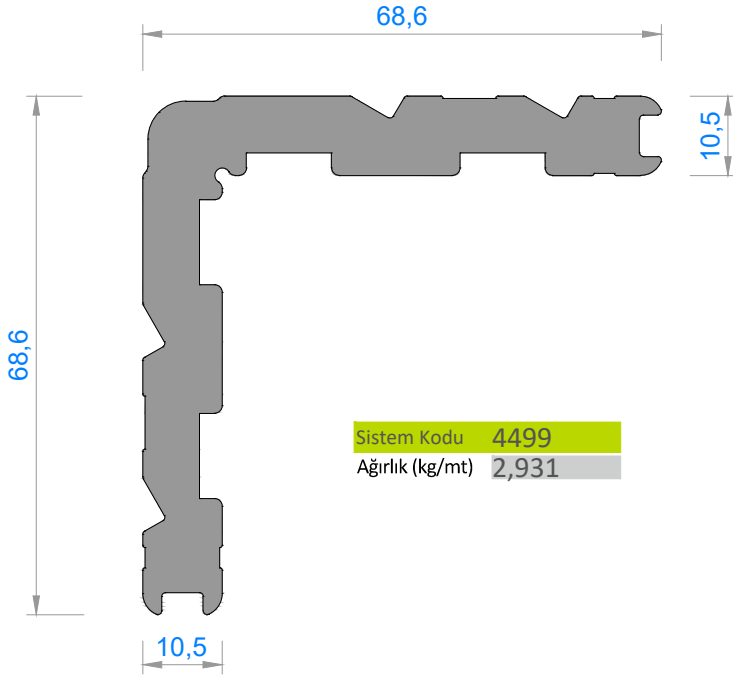
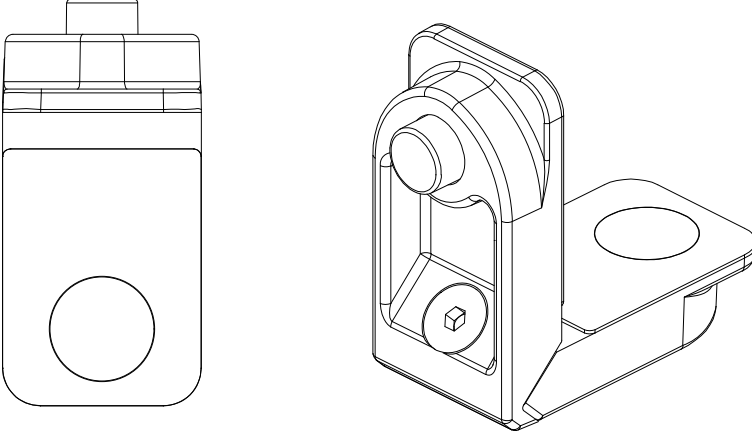

Sistem Kodu	7621*
Ağırlık (kg/mt)	0,225

ALYAN KÖŞE BİRLEŞTİRME - IMPORTED CORNER JOINT
LC - 1125

KÖŞE TAKOZLARI (CORNER JOINT)

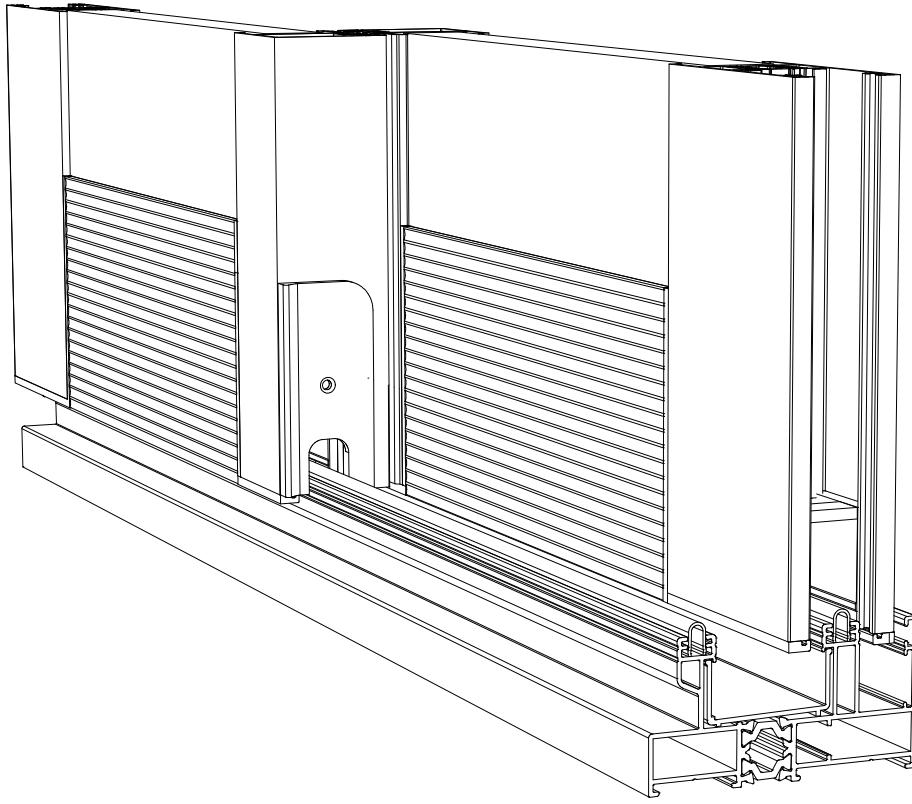
Nr	 L m	 AKS. KODU ACS. CODE	KESİM ÖLÇÜSÜ CUTTING SIZE
7600-7601	4499	4499 - 24	24 mm
	4499	4499 - 24	24 mm
7602-7601	4499	4499 - 24	24 mm
	4499	4499 - 24	24 mm
7603-7604	4499	4499 - 24	24 mm
	4499	4499 - 24	24 mm
7605-7604	4499	4499 - 24	24 mm
	4499	4499 - 24	24 mm
	4499	4499 - 24	24 mm
7600-7606-7601	4499	4499 - 24	24 mm
	4499	4499 - 24	24 mm
	4499	4499 - 24	24 mm
7602-7606-7601	4499	4499 - 24	24 mm
	4499	4499 - 24	24 mm
	4499	4499 - 24	24 mm



FAUSTO MİMARİ SİSTEMLER

32ST SİSTEM DETAYLARI

32ST SYSTEM DETAILS

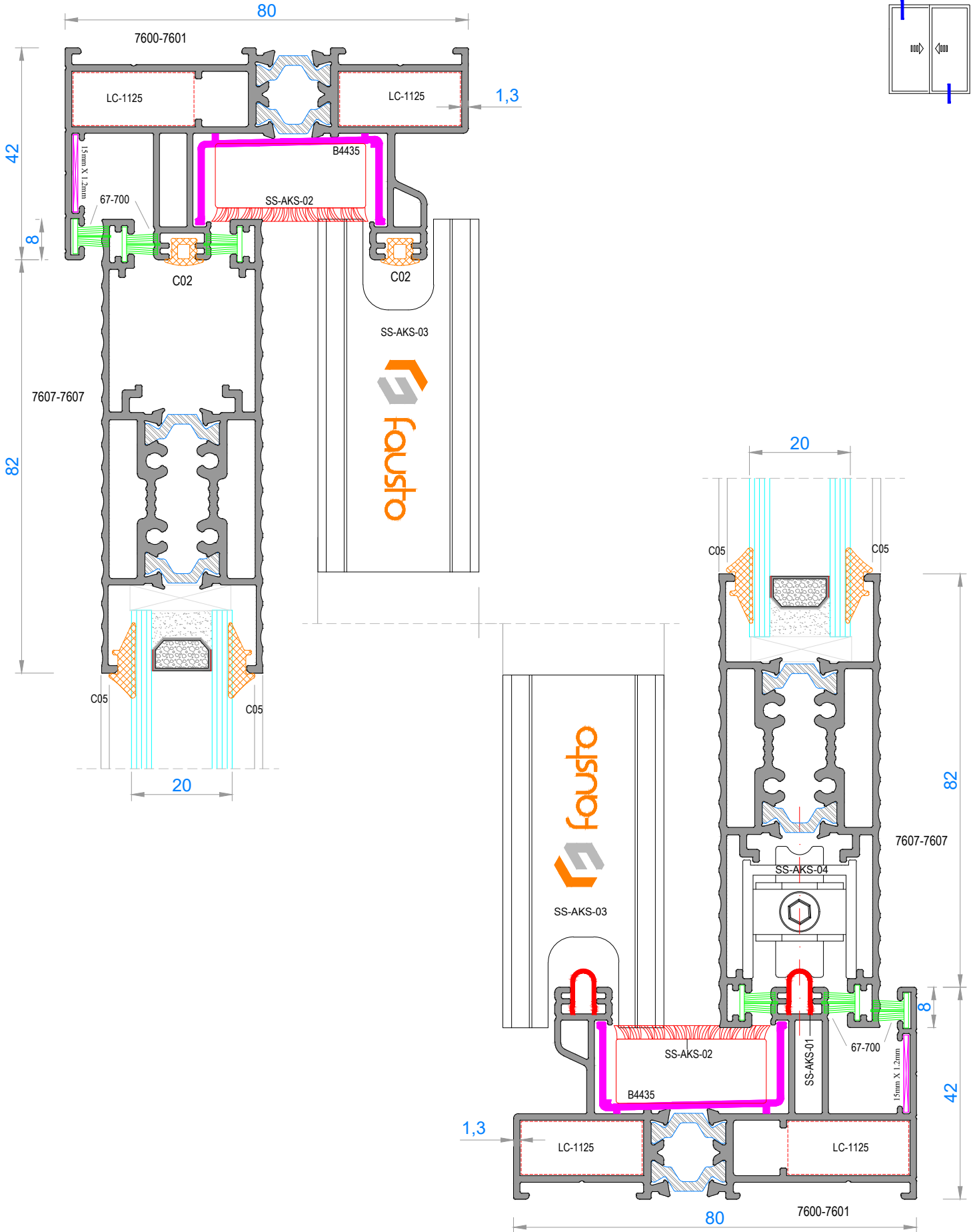

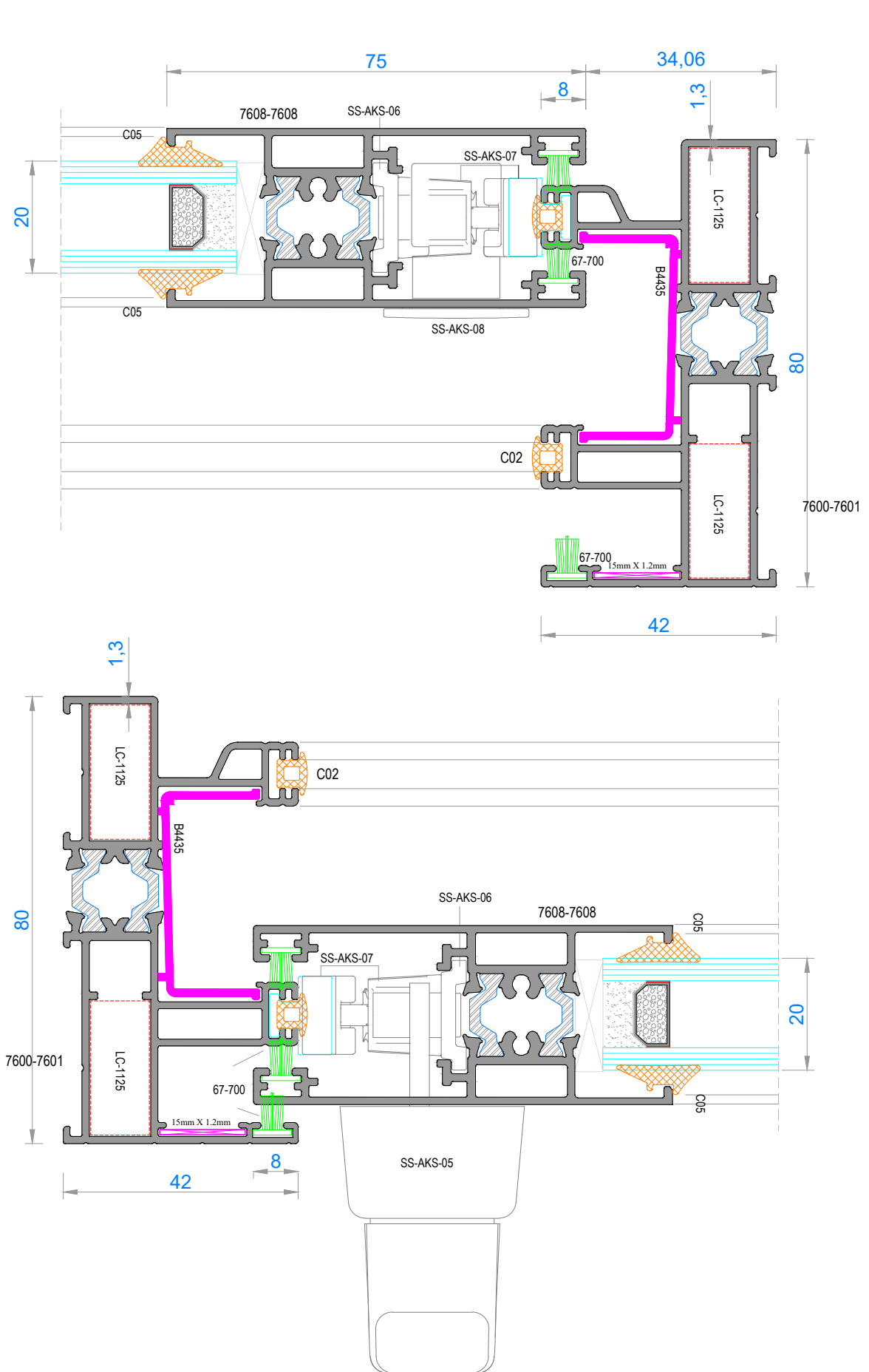

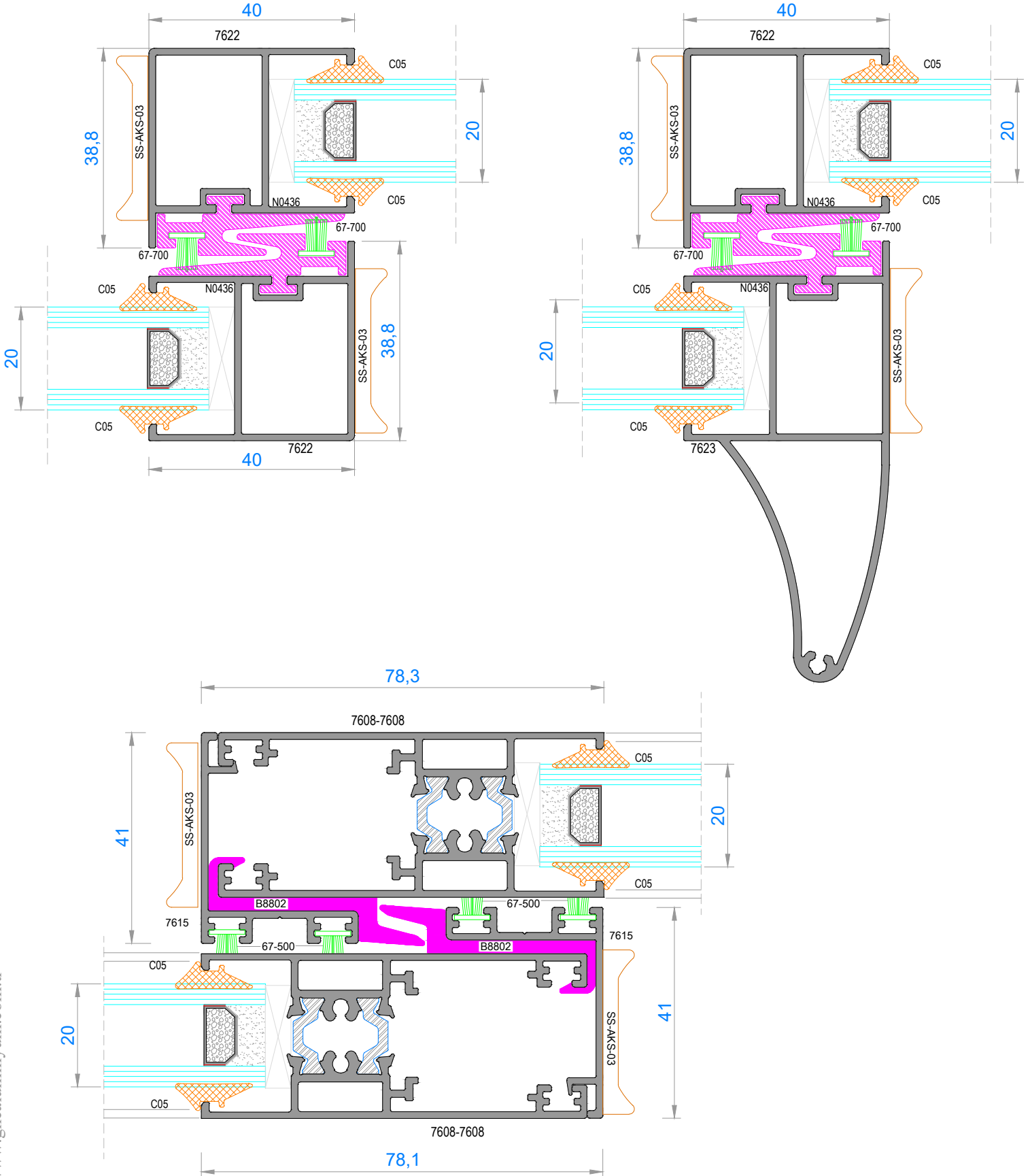
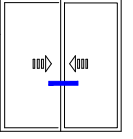

NOT: Profil ağırlıkları teoriktir, üretim sonrası ağırlıklar geçerlidir.

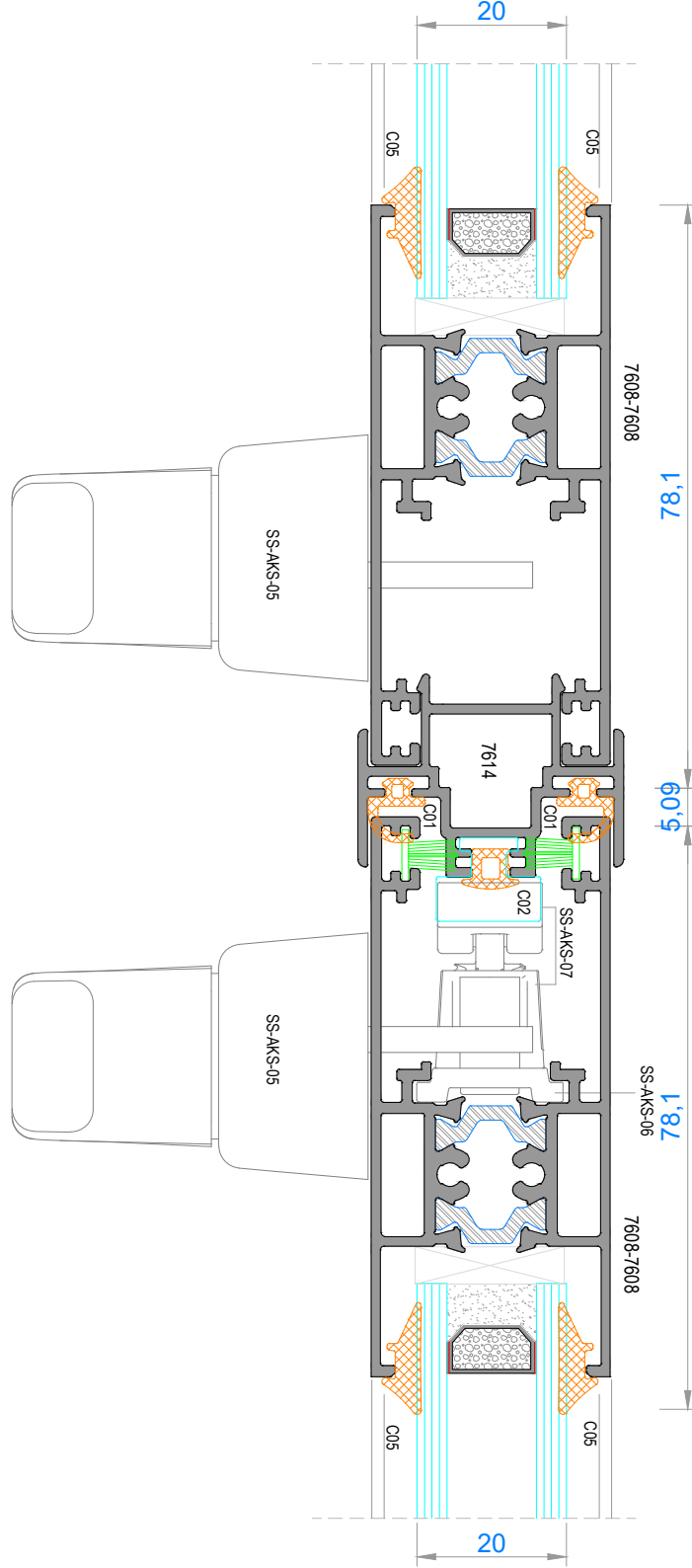
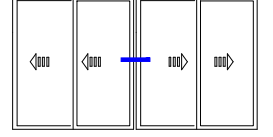

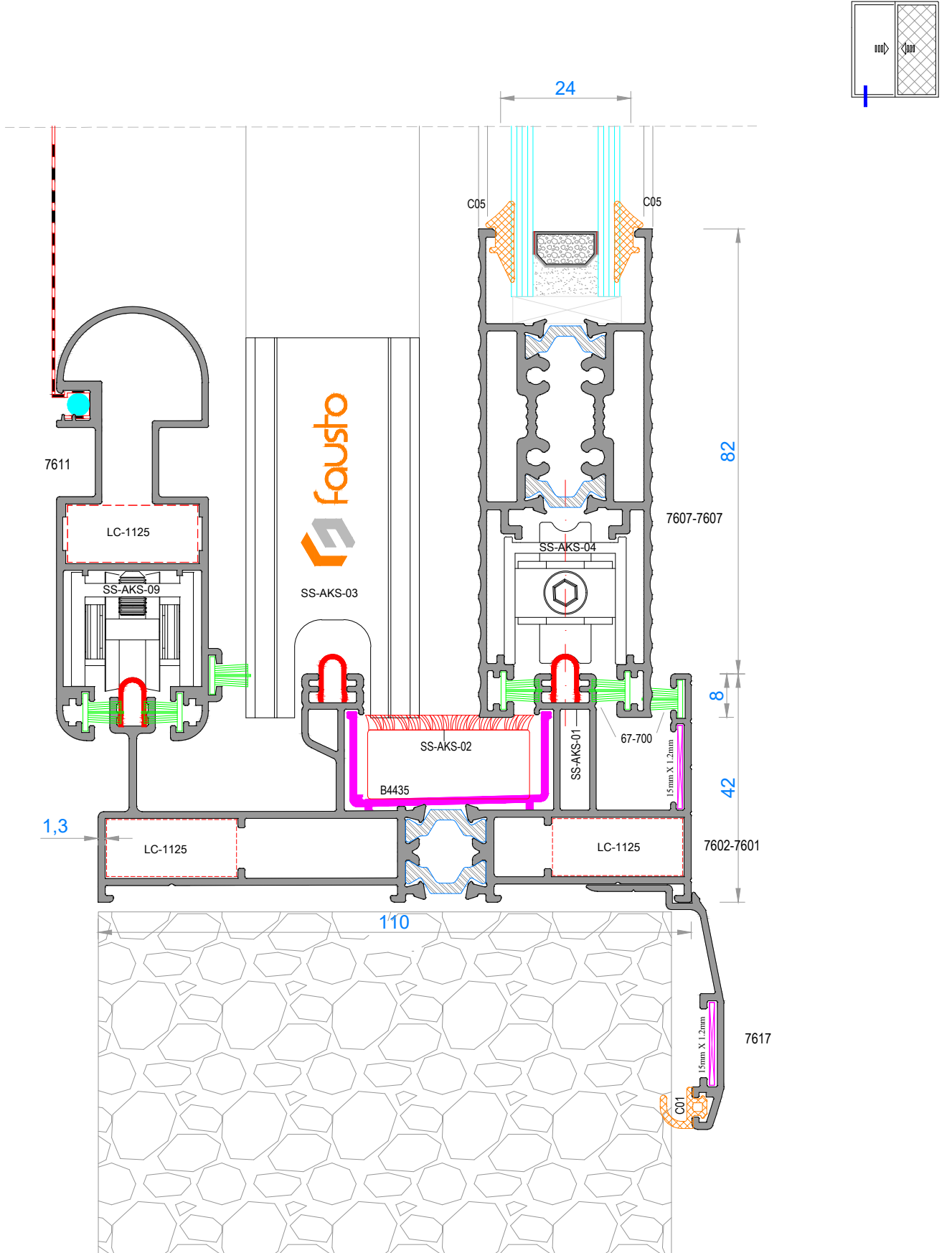

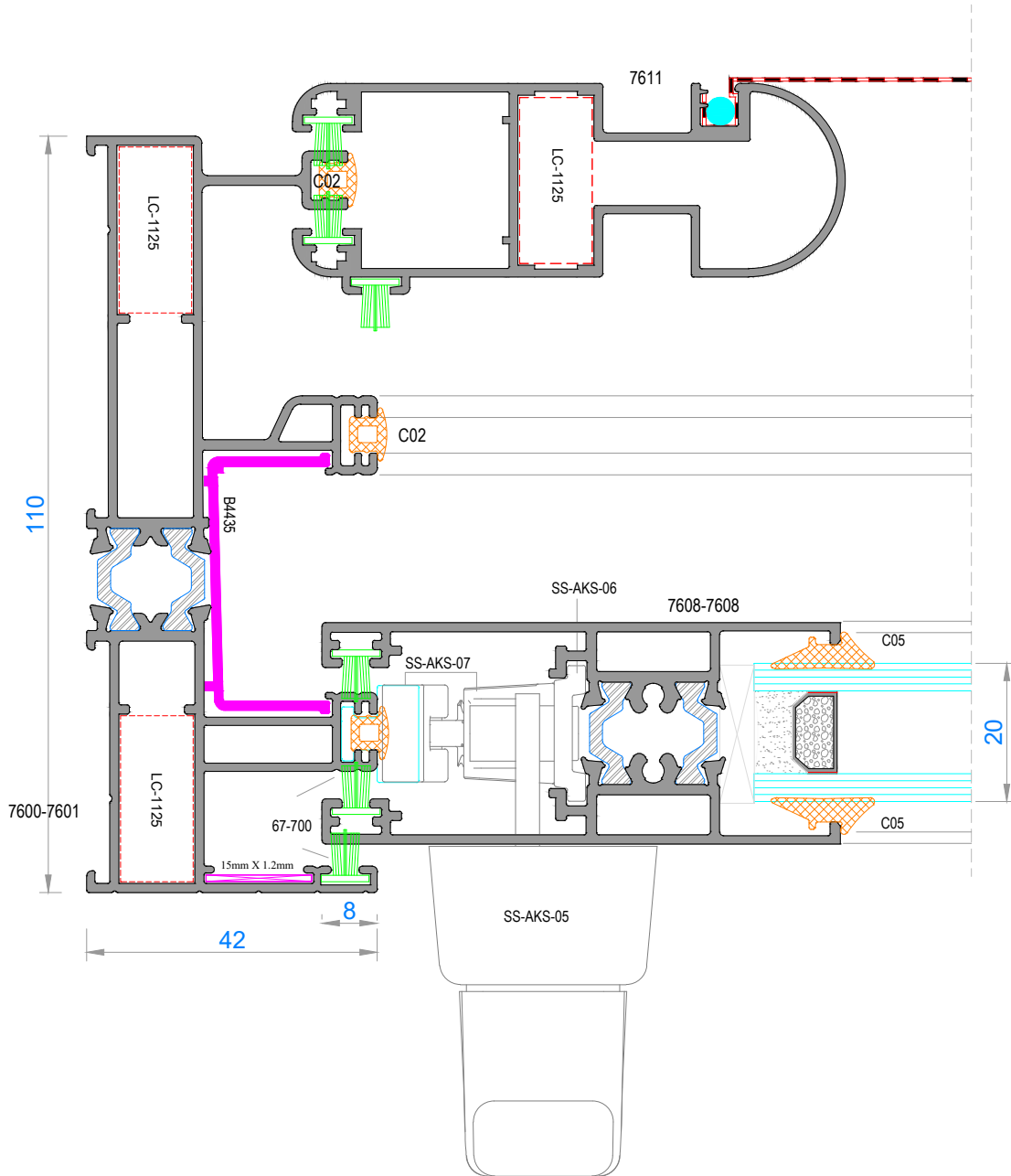
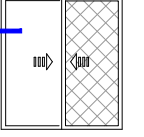

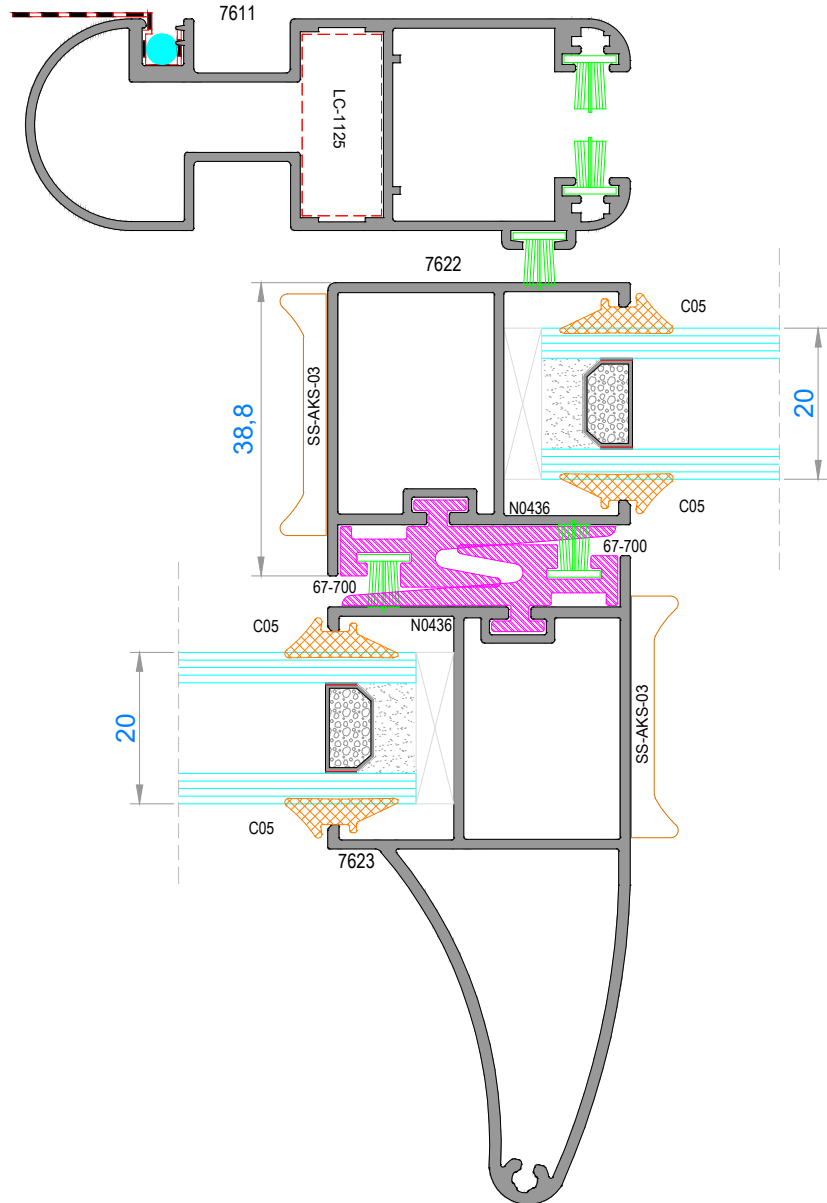
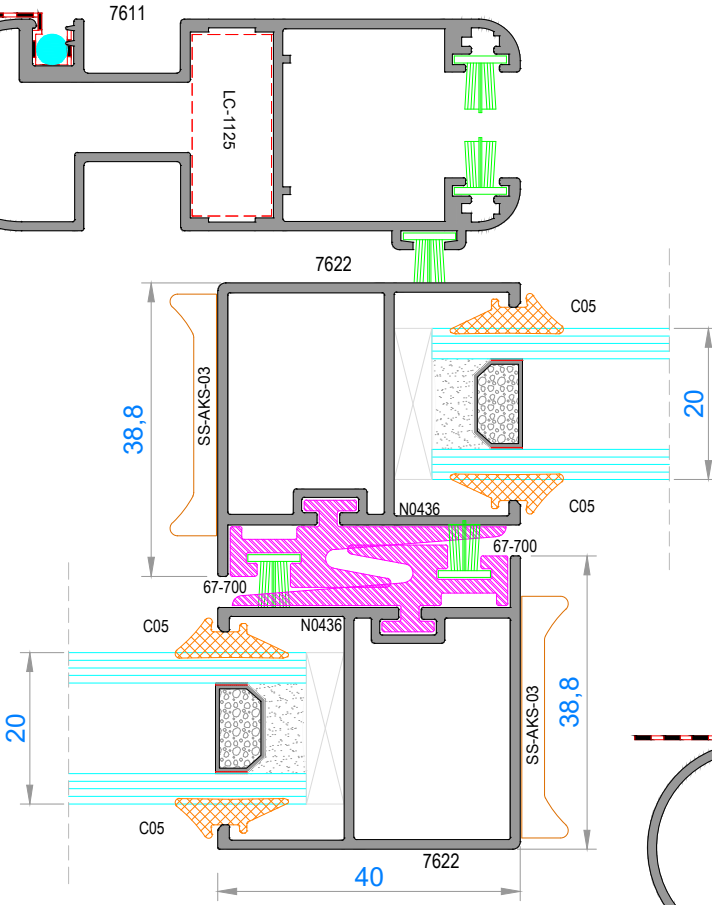
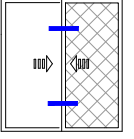

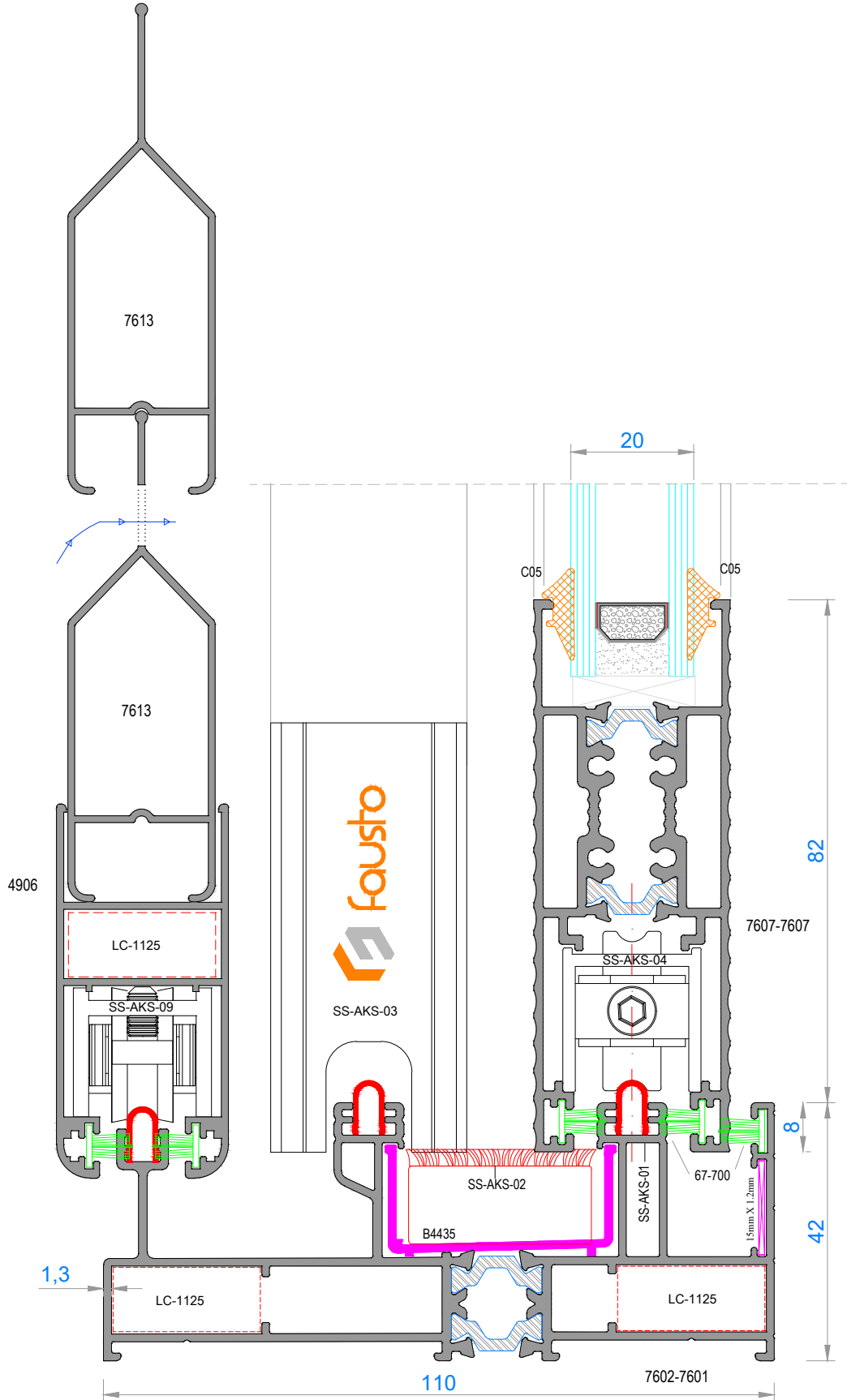
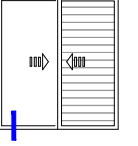

NOT: Profil ağırlıkları teoriktir, üretim sonrası ağırlıklar geçerlidir.

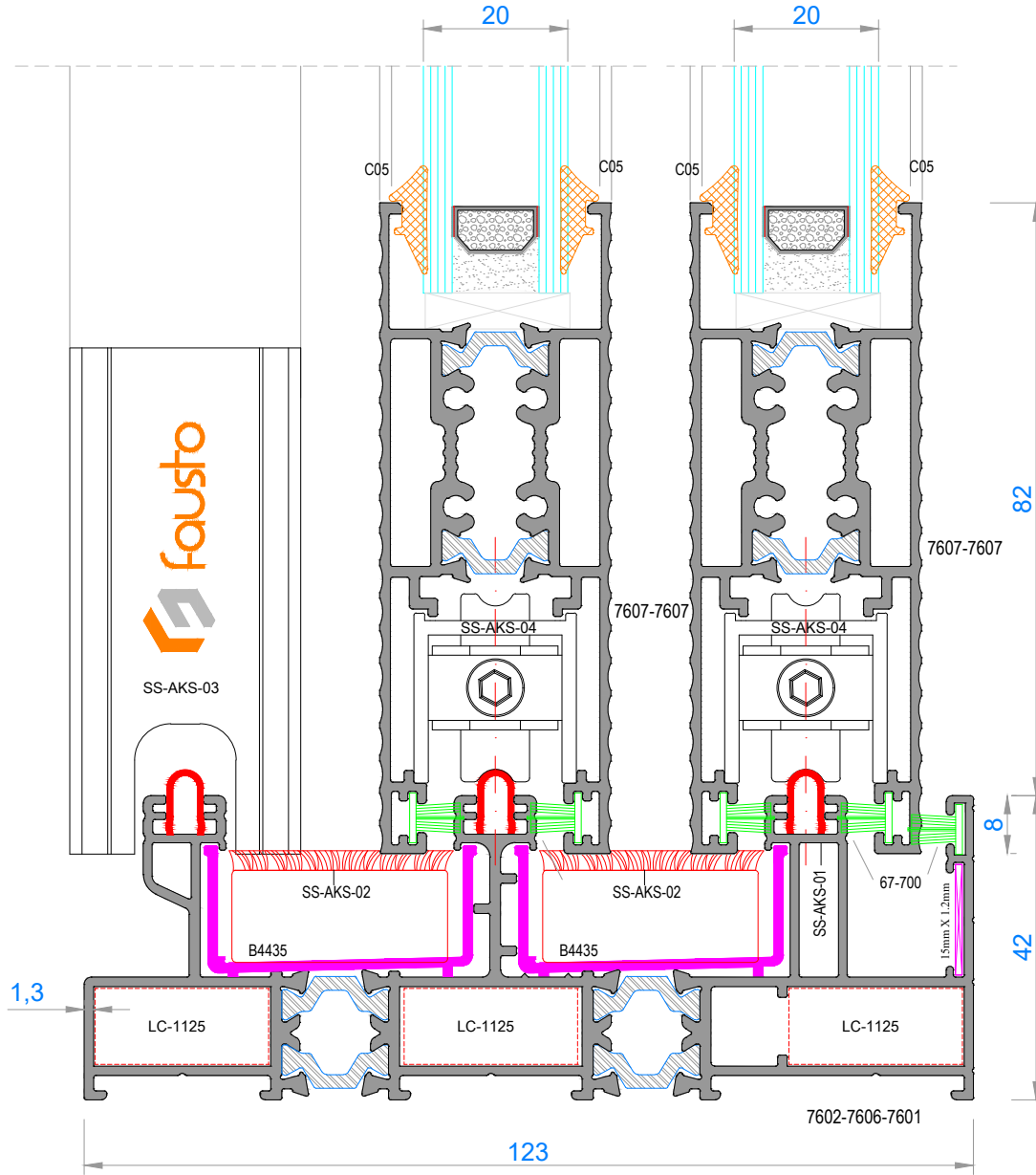
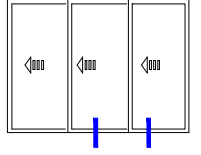

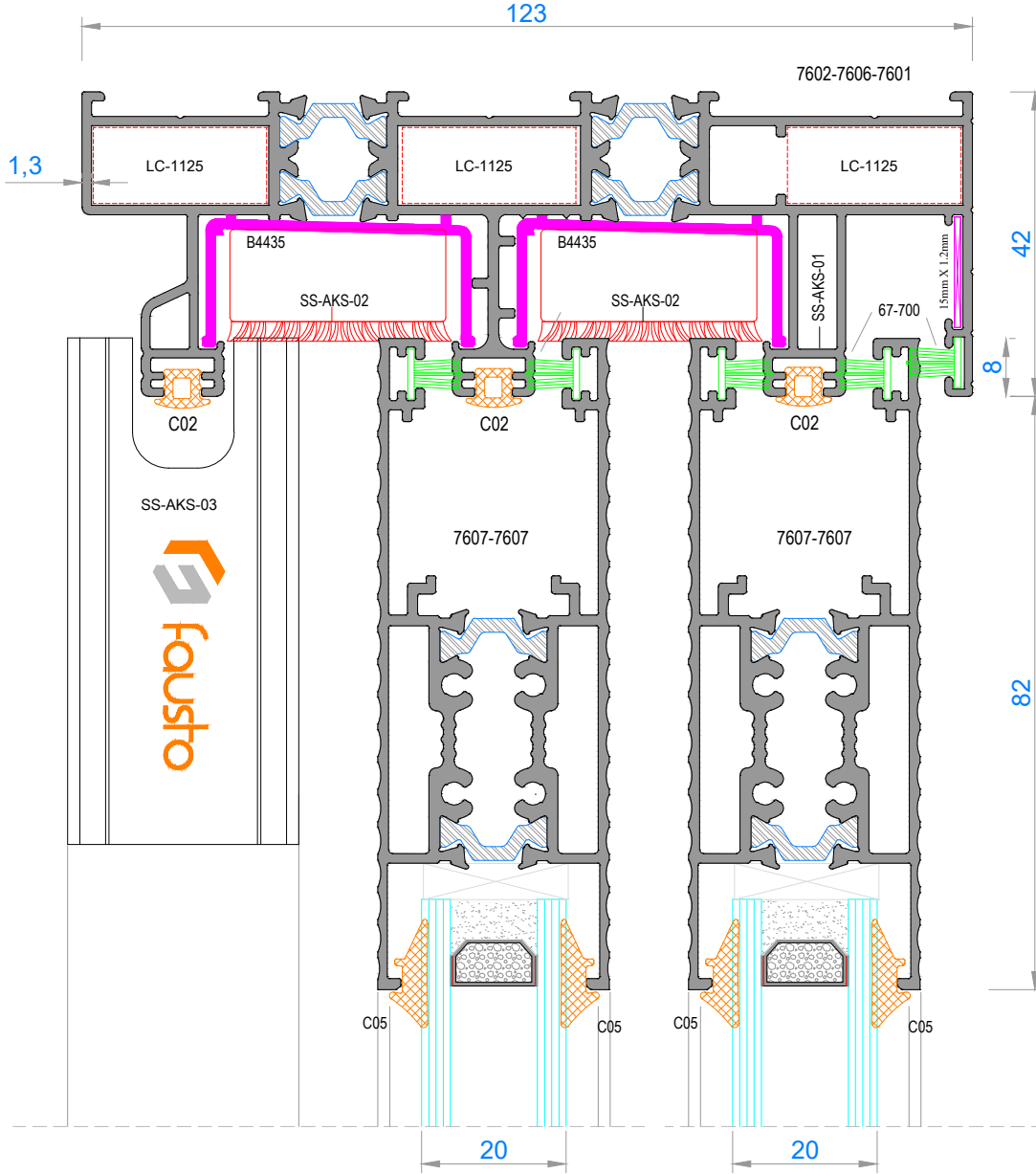
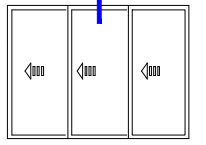

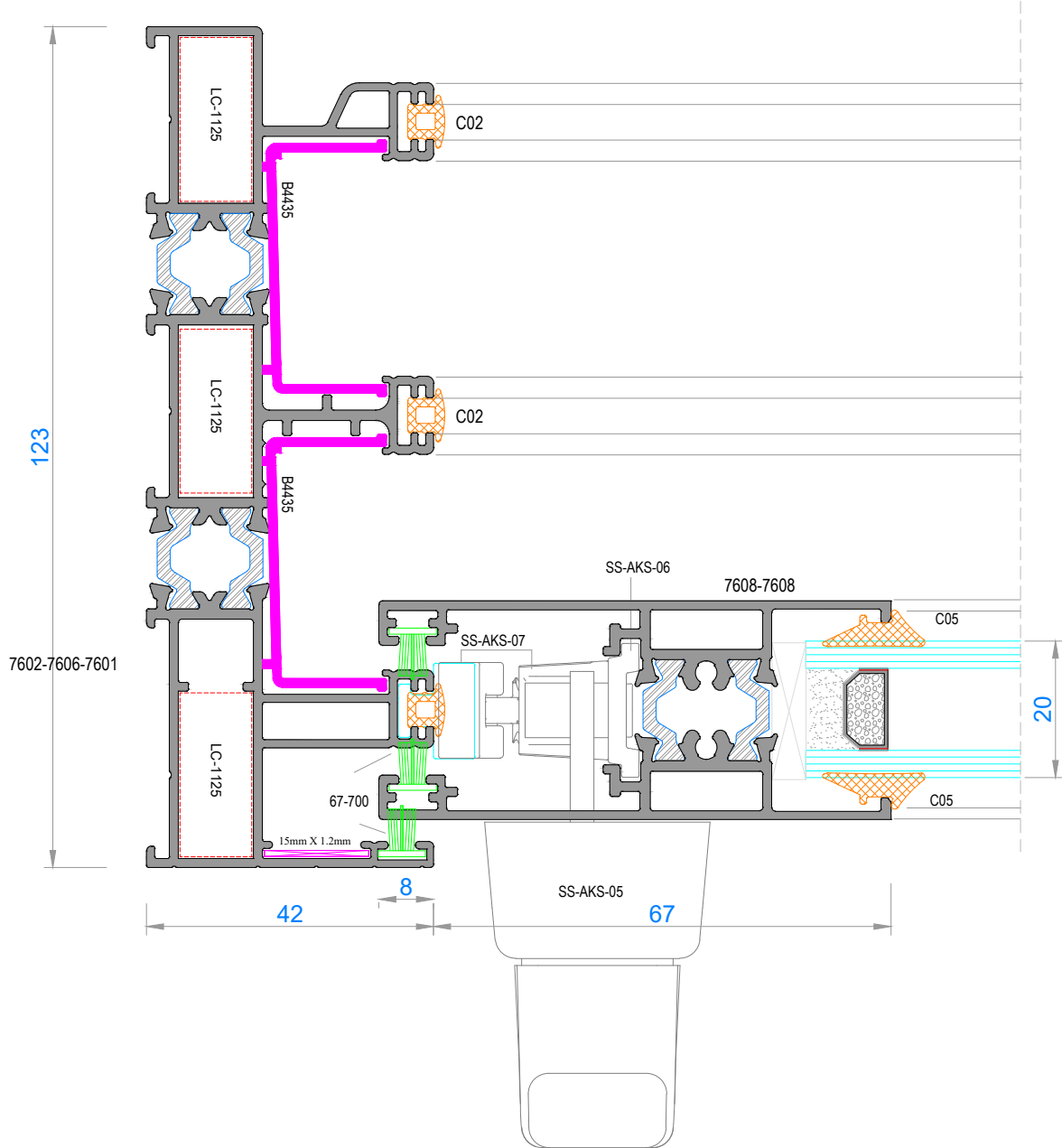
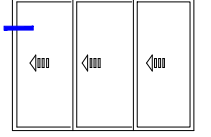

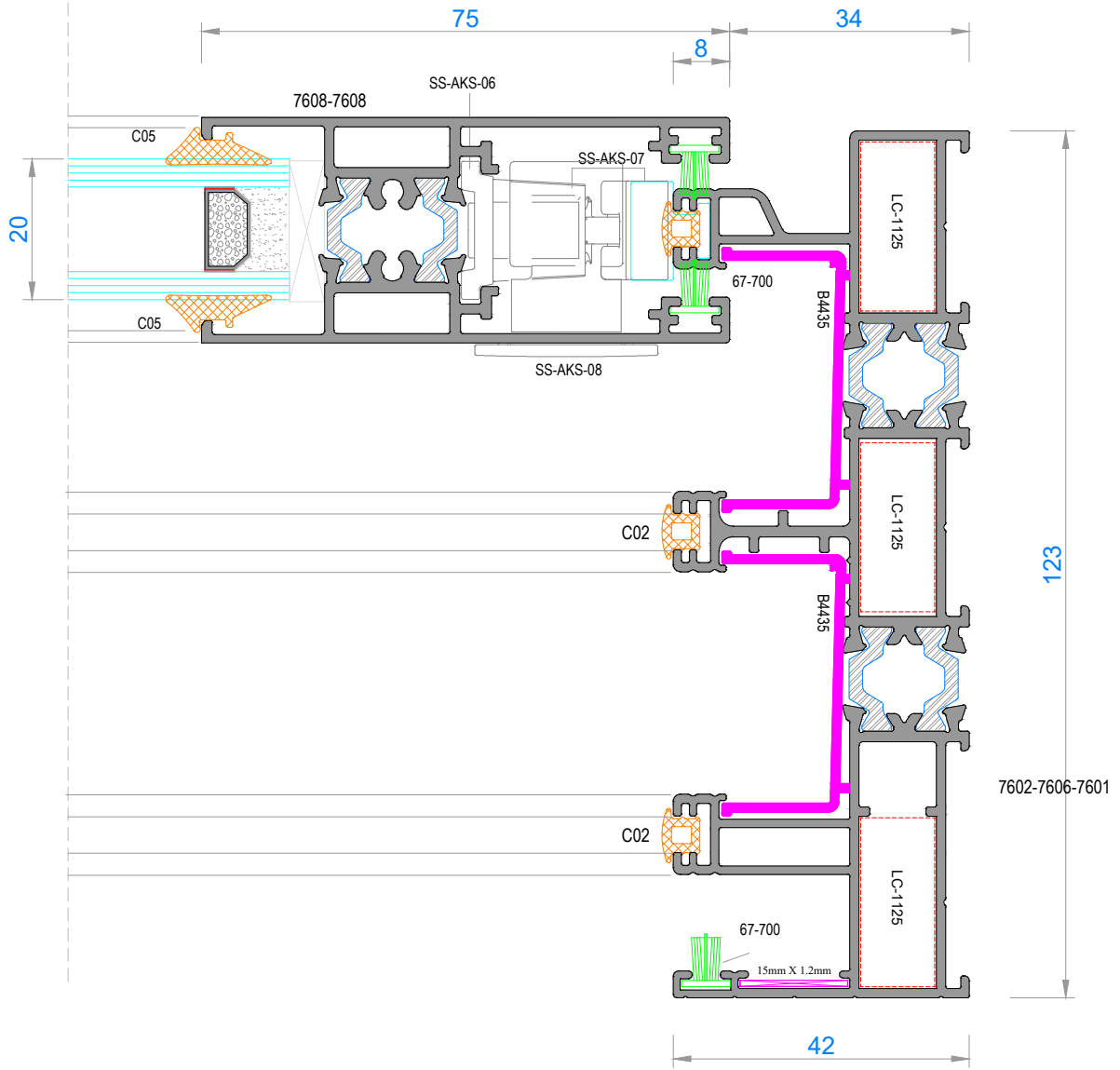
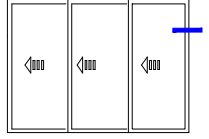

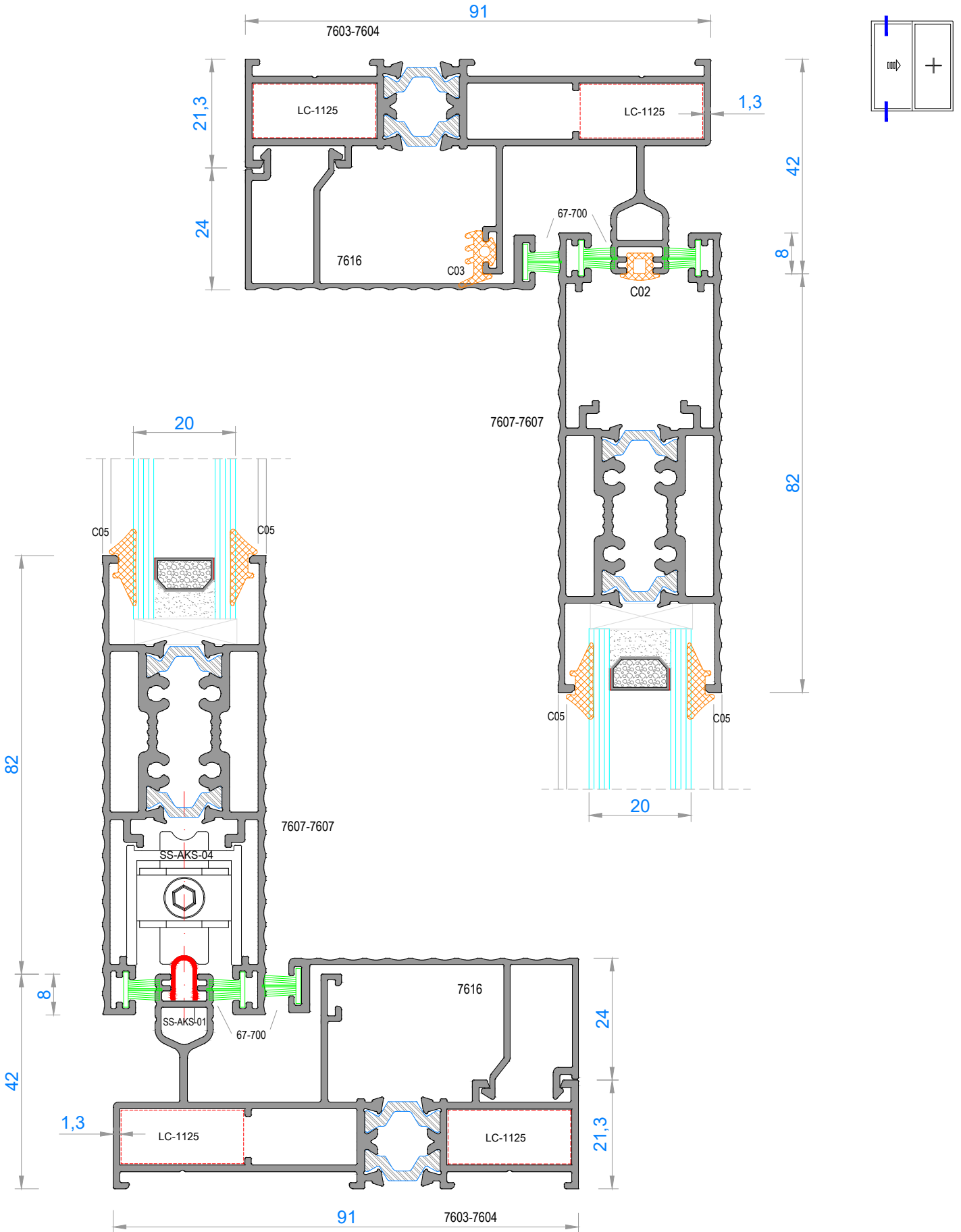

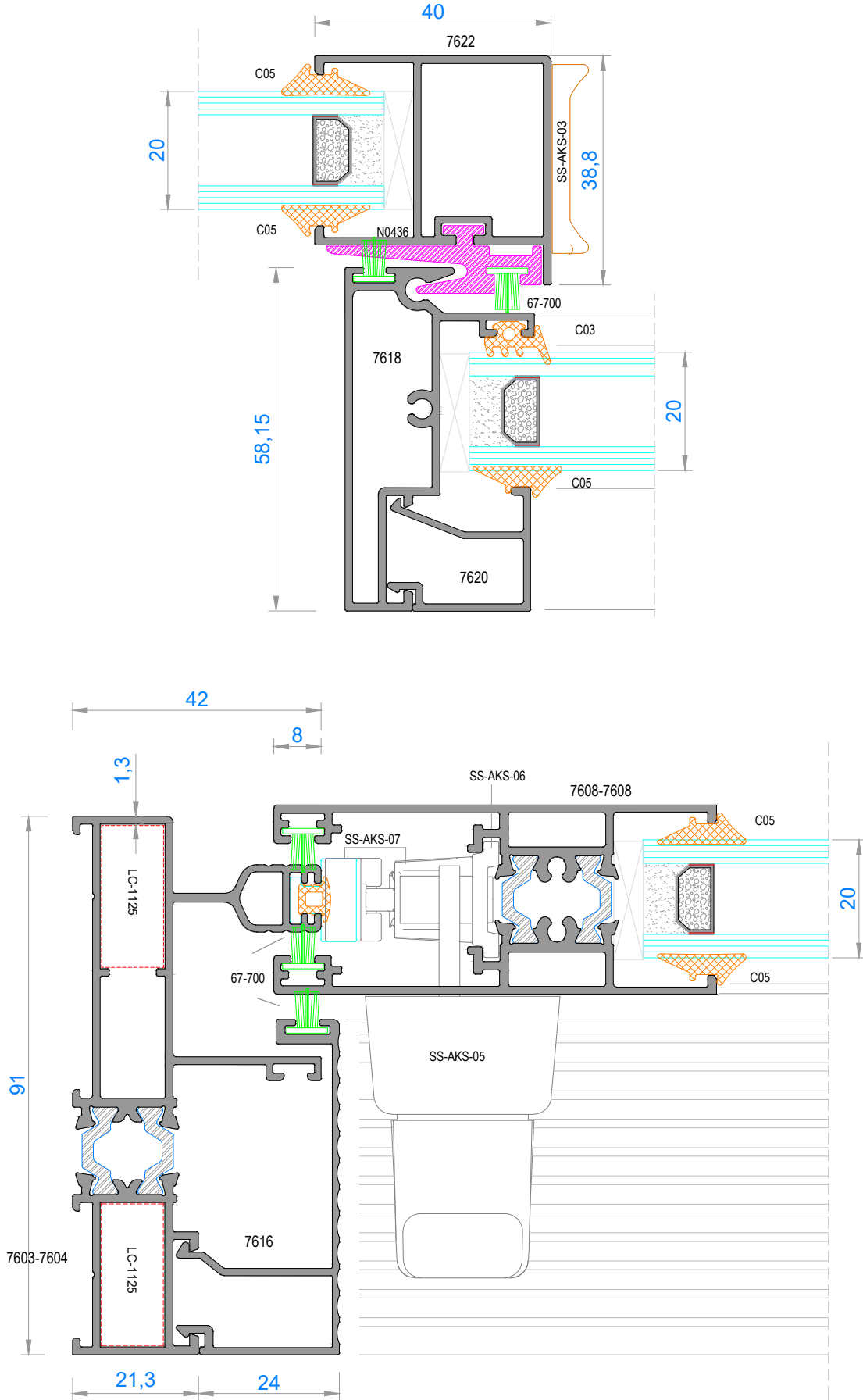

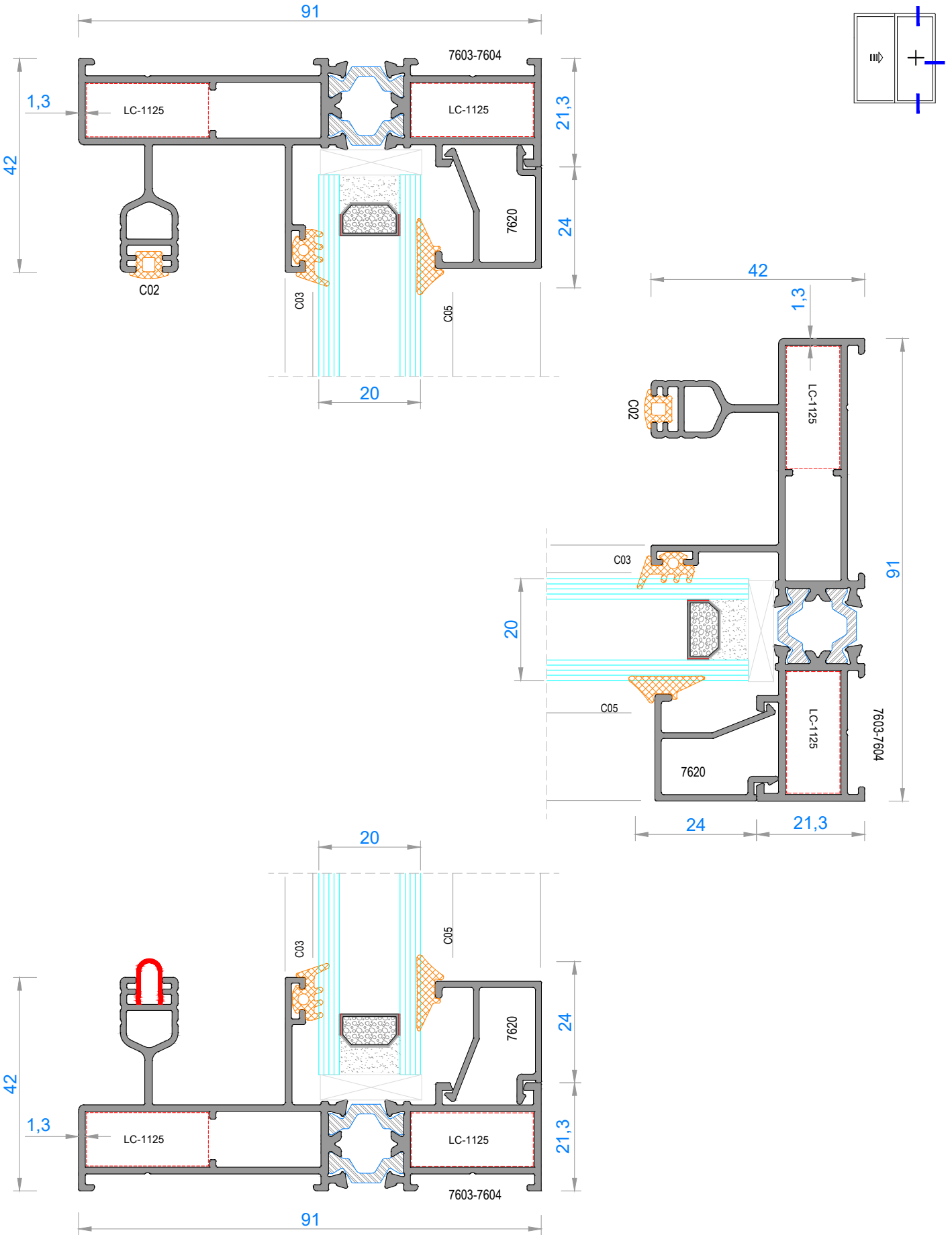

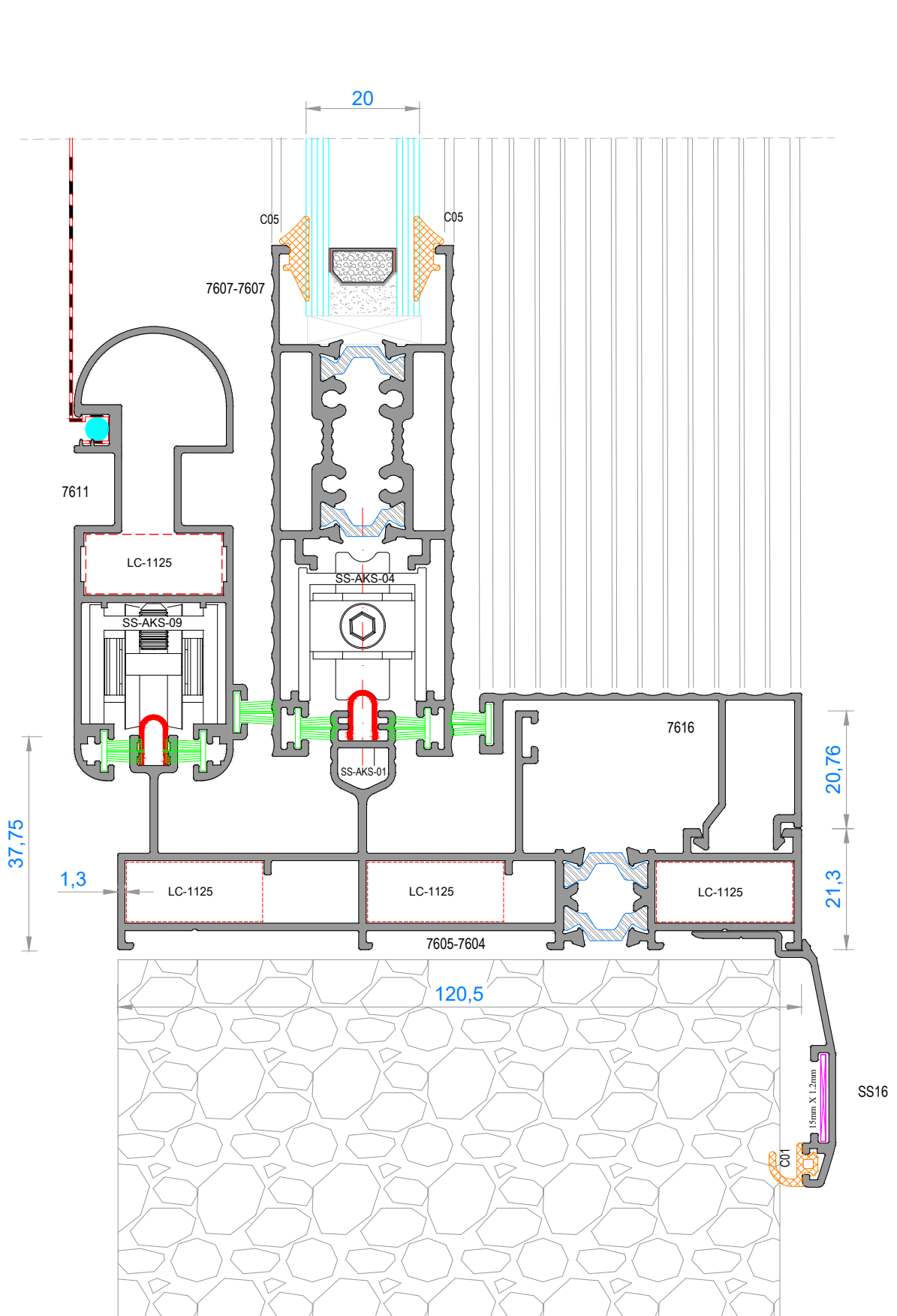

NOT: Profil ağırlıkları teoriktir, üretim sonrası ağırlıklar geçerlidir.

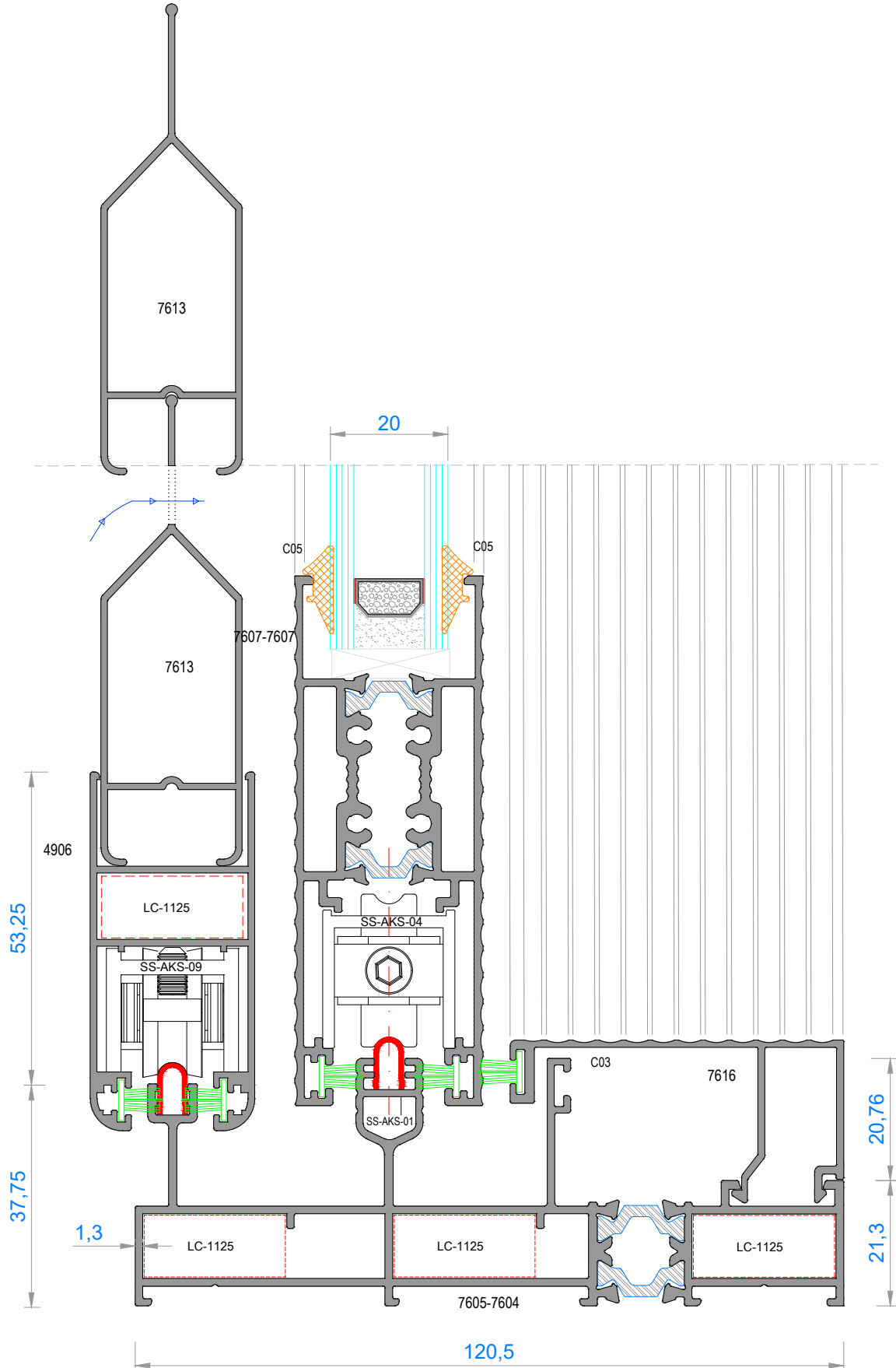
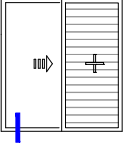

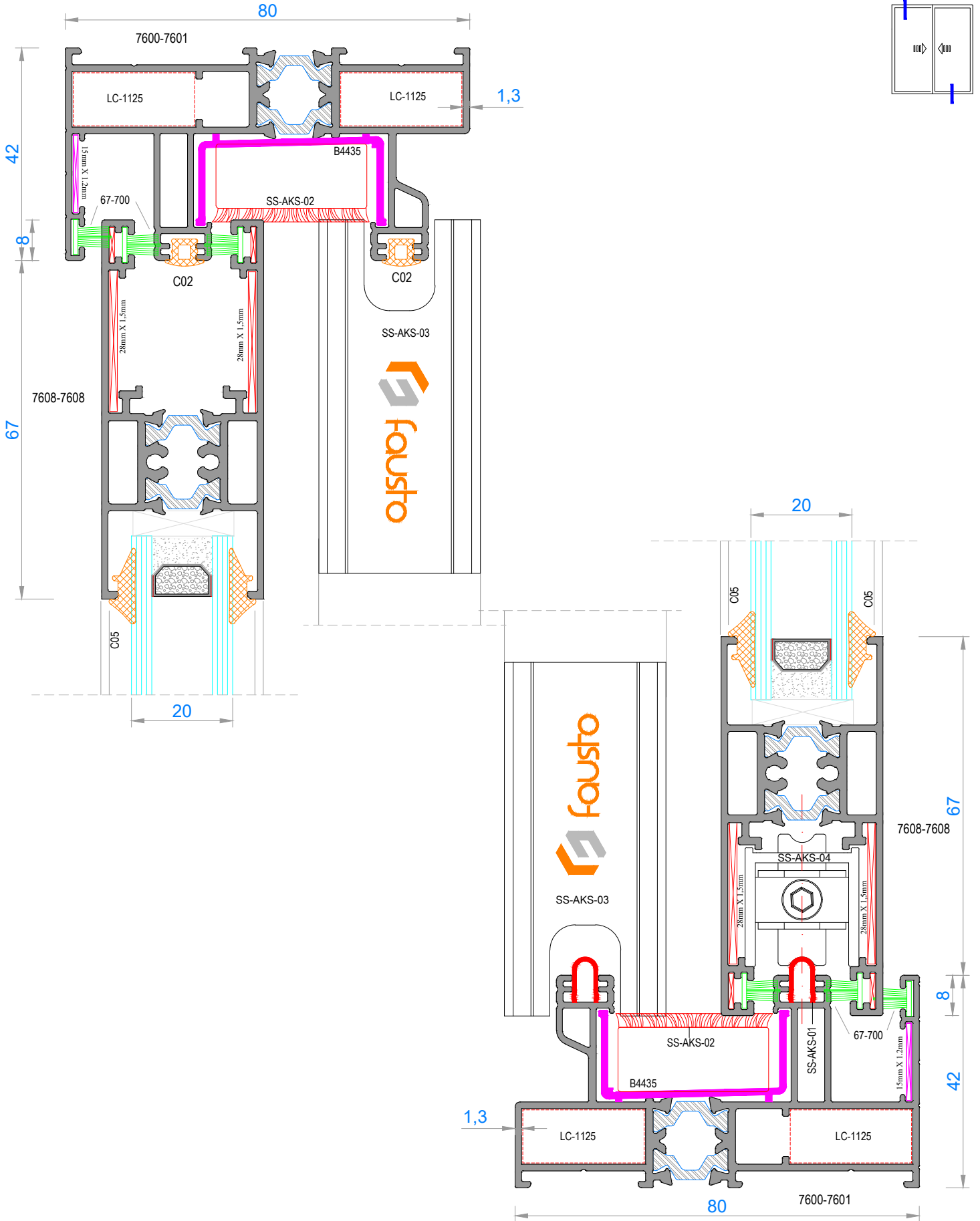

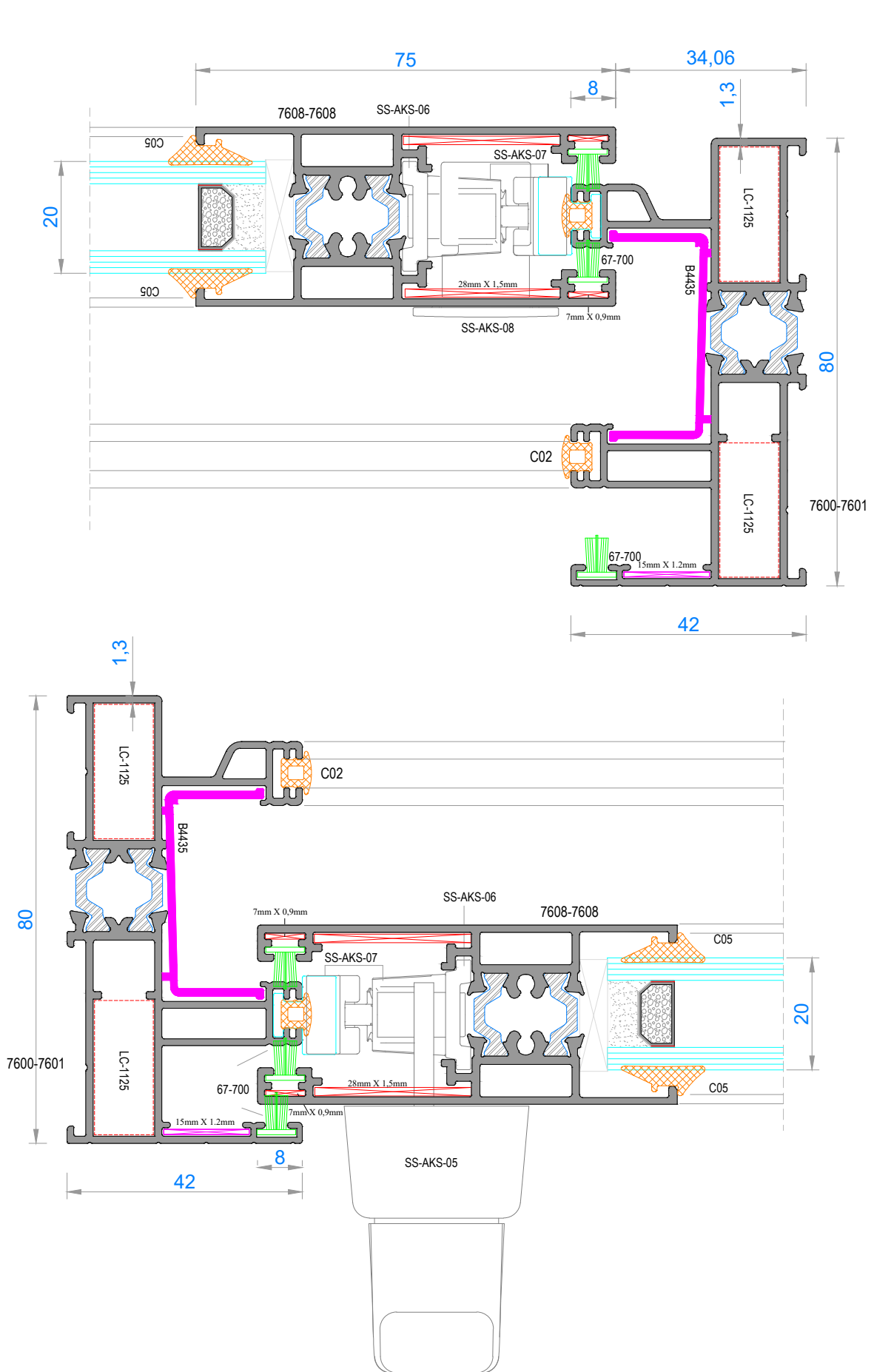

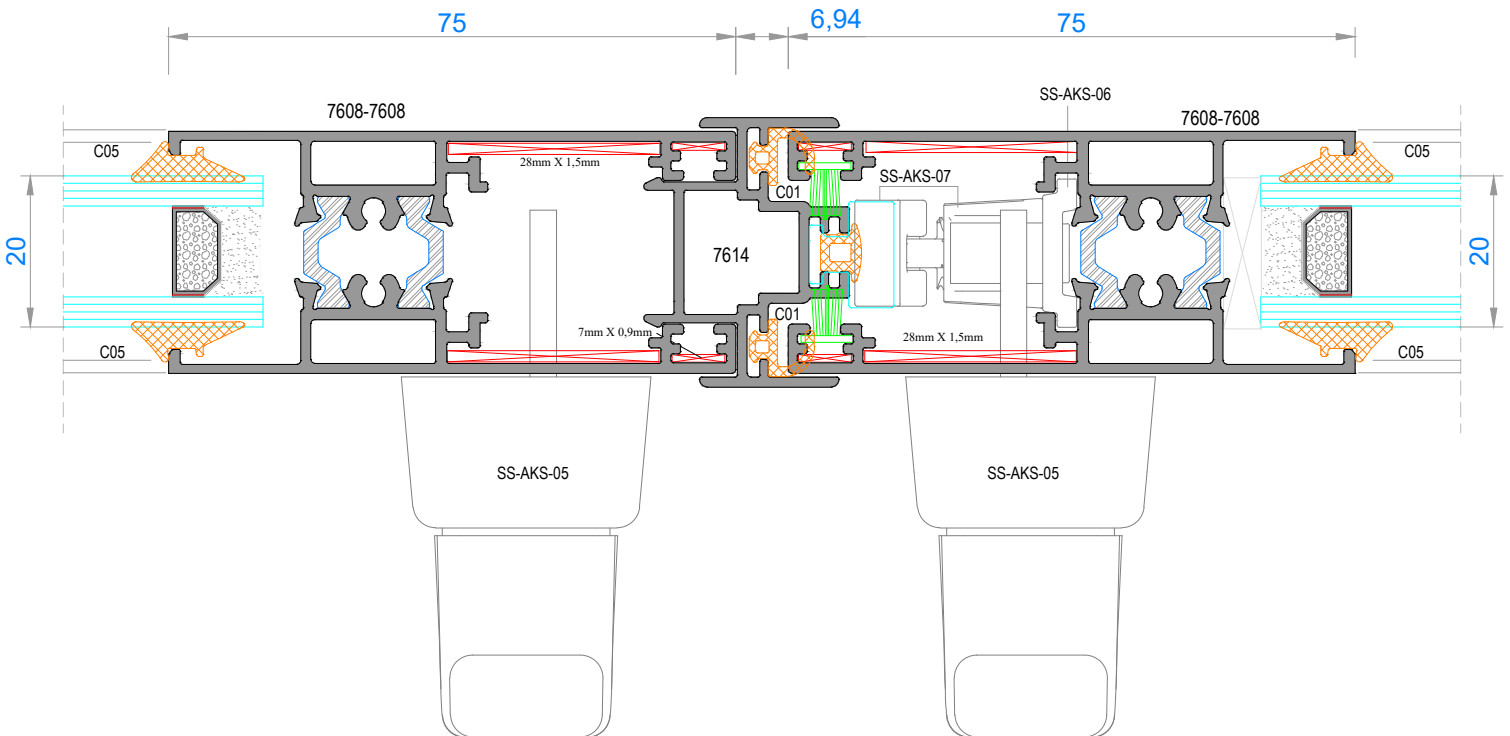
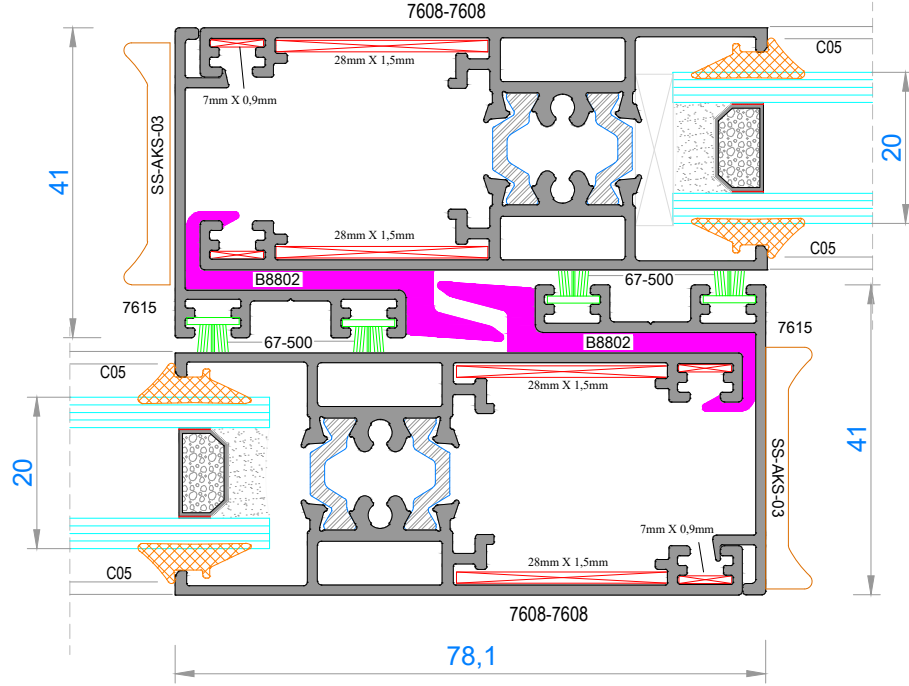
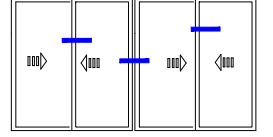

NOT: Profil ağırlıkları teoriktir, üretim sonrası ağırlıklar geçerlidir.

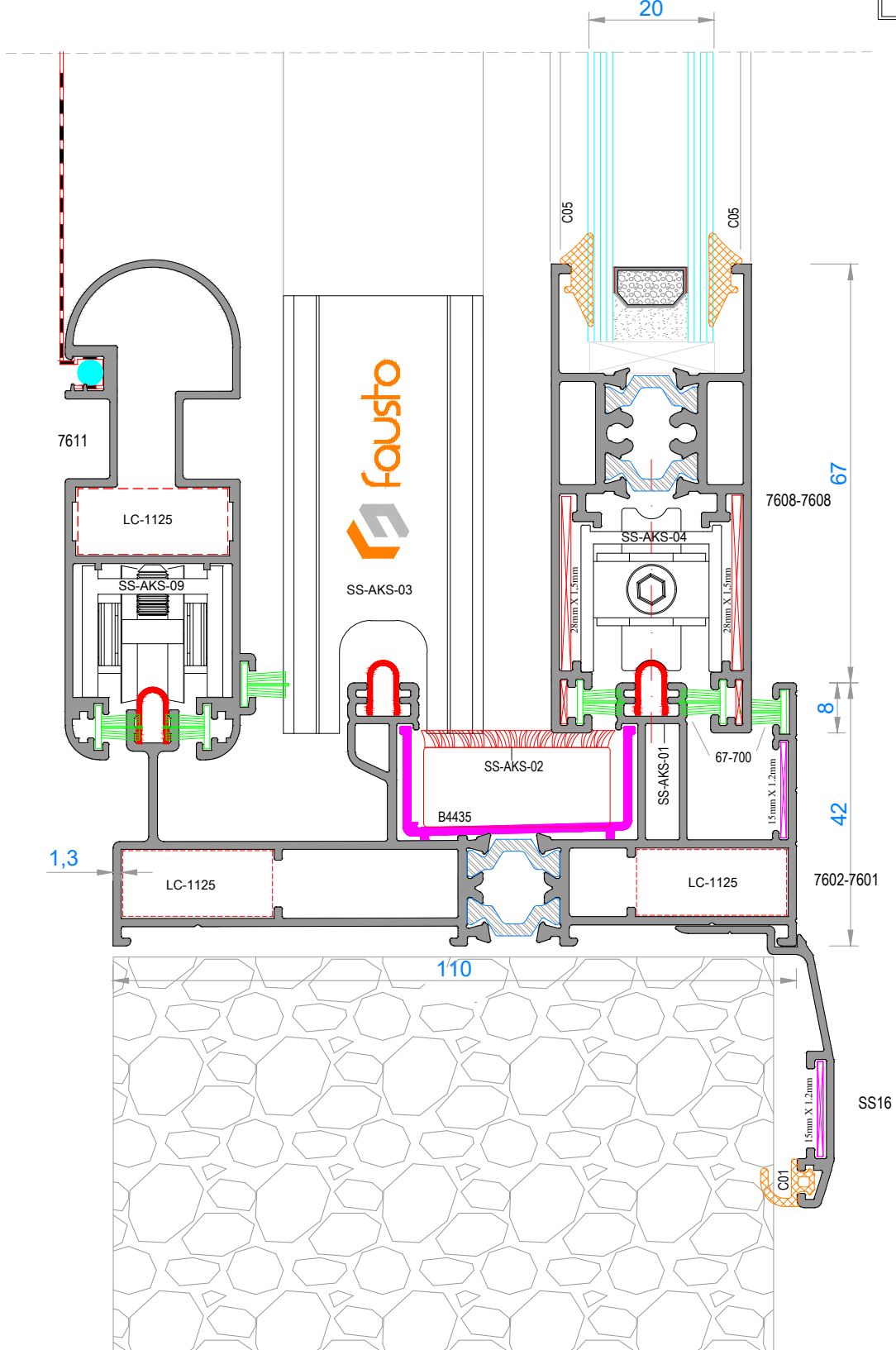
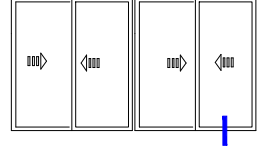

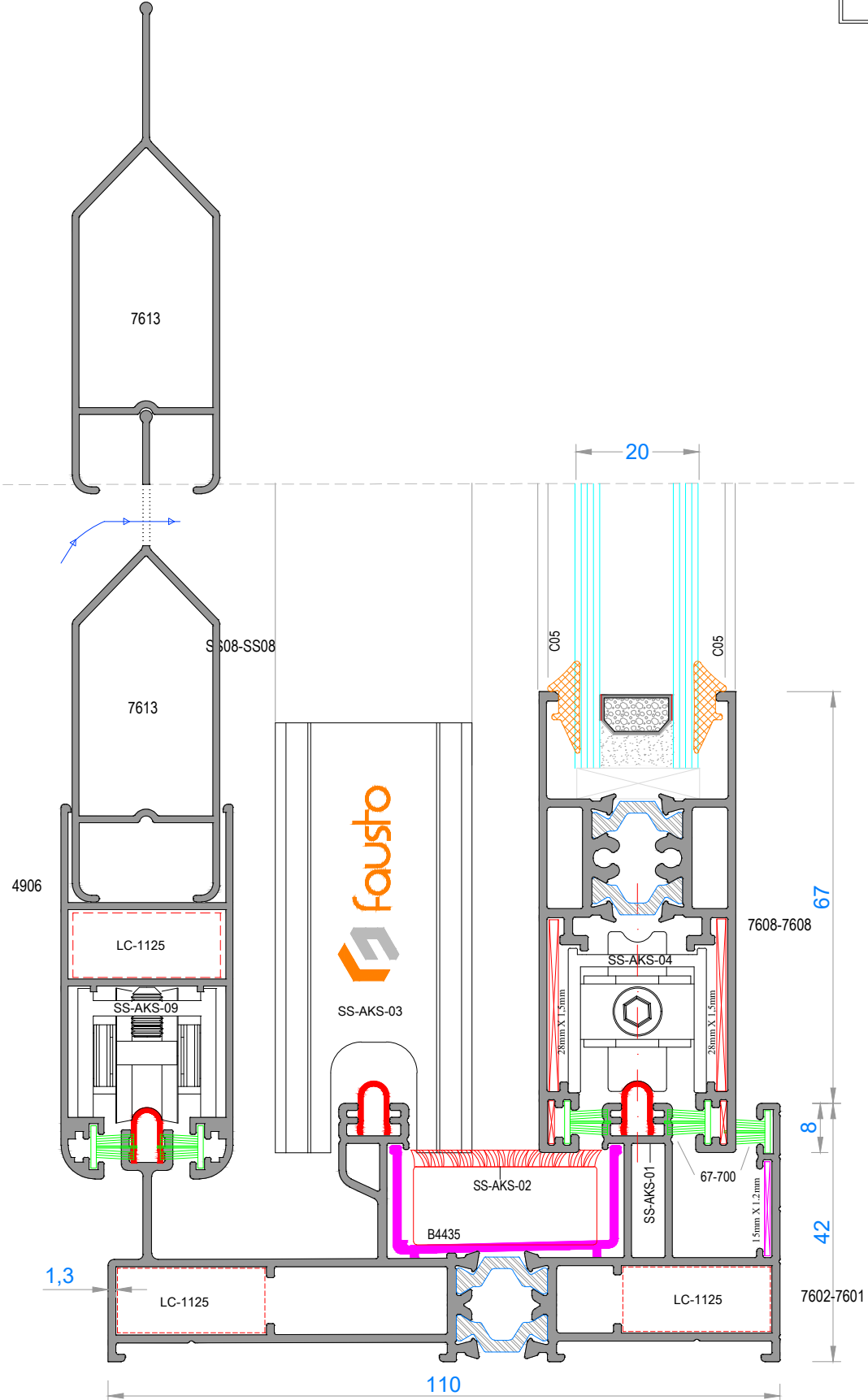
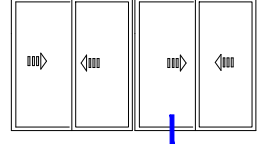

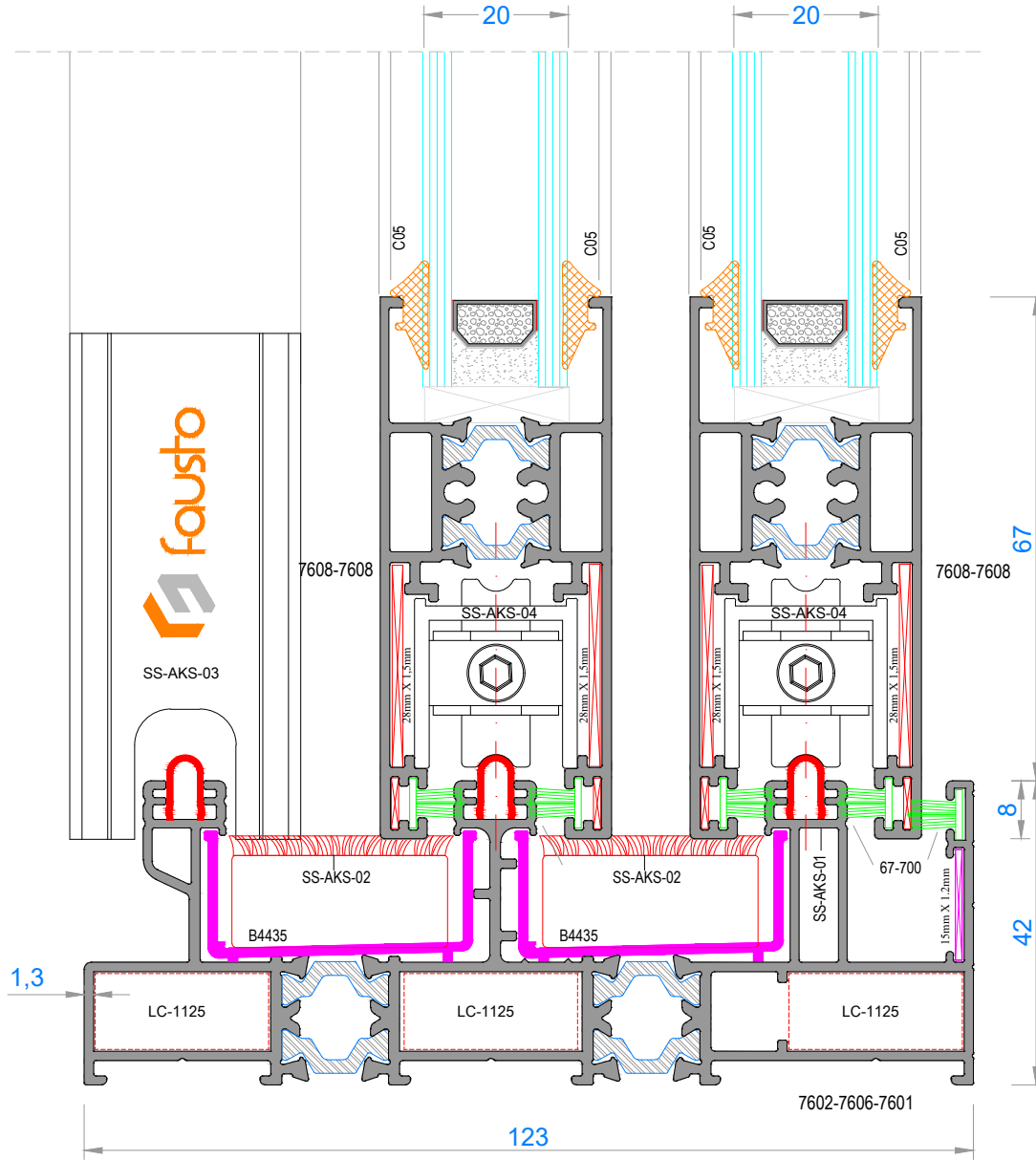
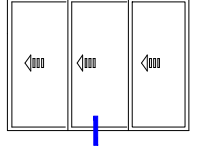

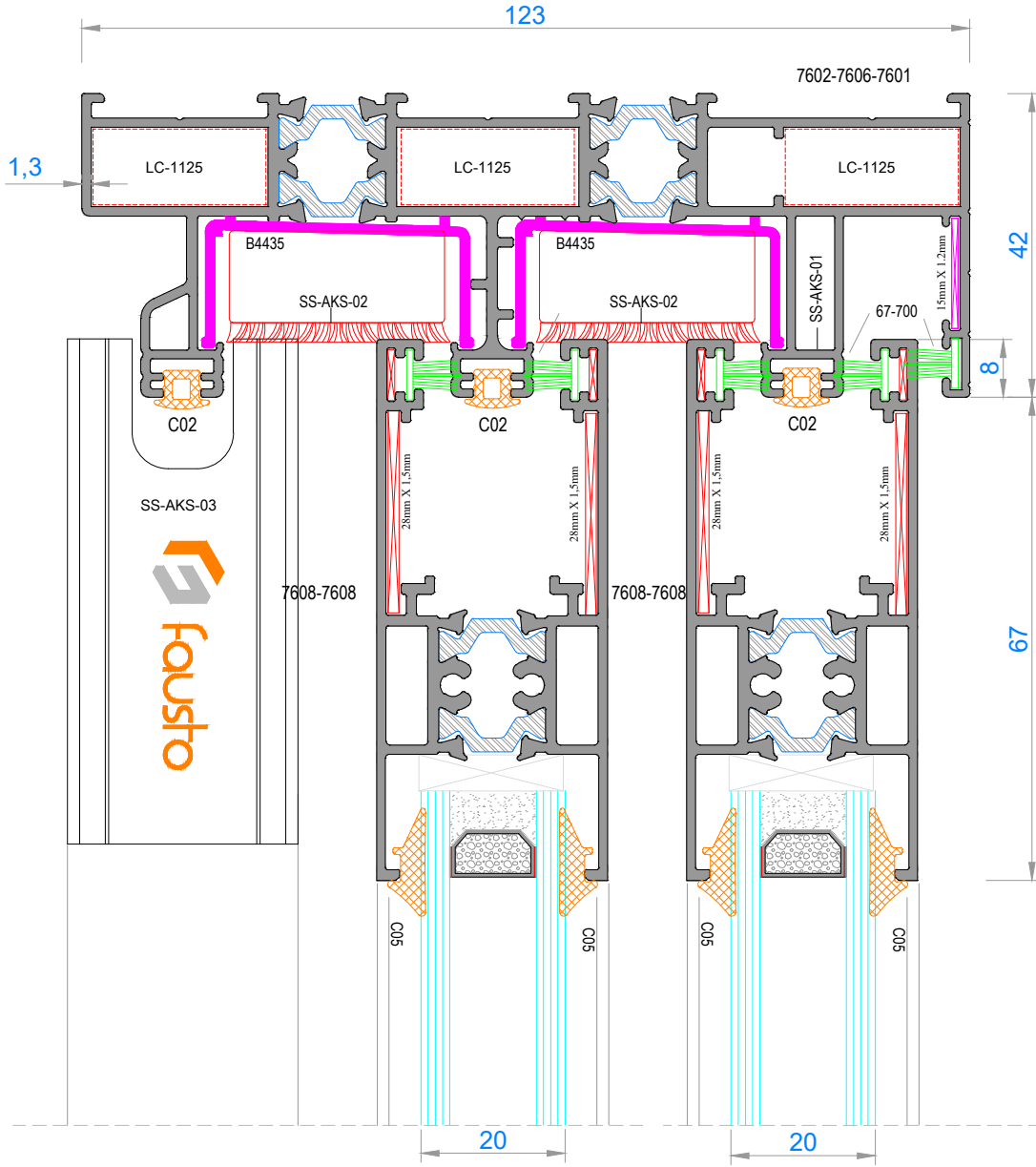
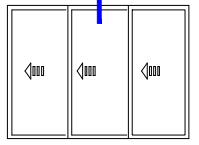

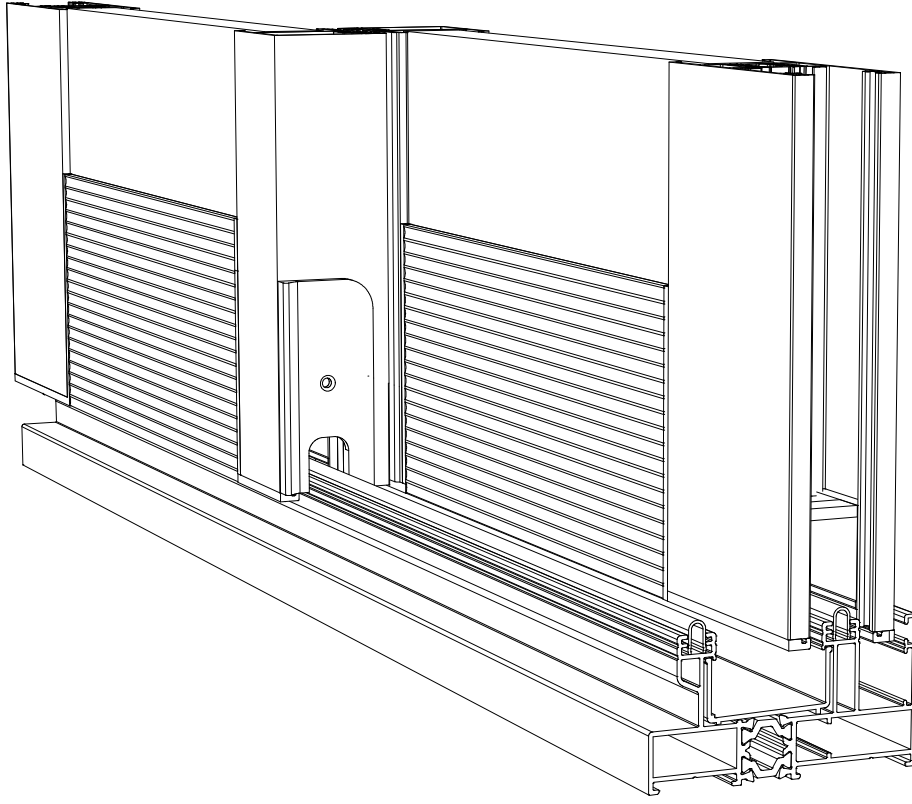
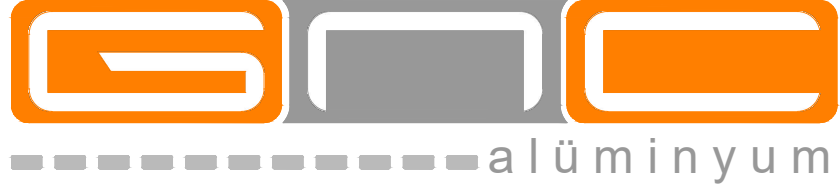

FAUSTO MİMARİ SİSTEMLER

32ST KURULUM VE ÜRETİM ŞEMALARI

32ST INSTALLATION AND PRODUCTION SCHEME

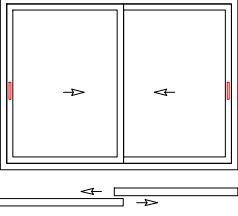
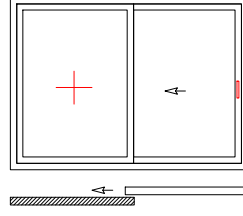
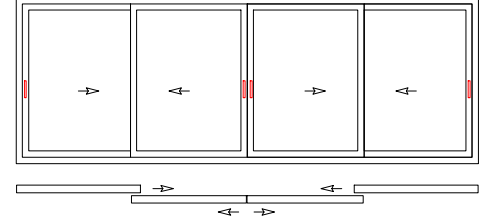
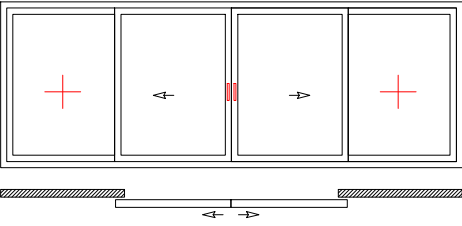
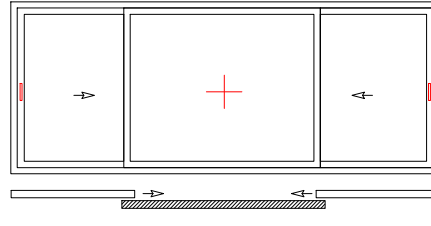
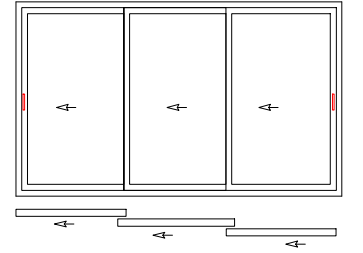
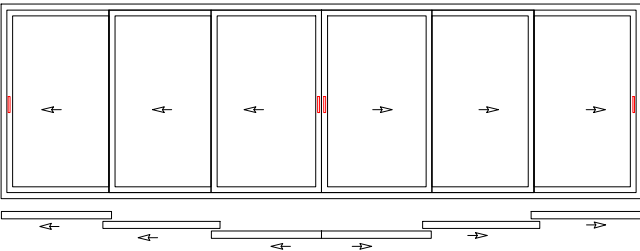
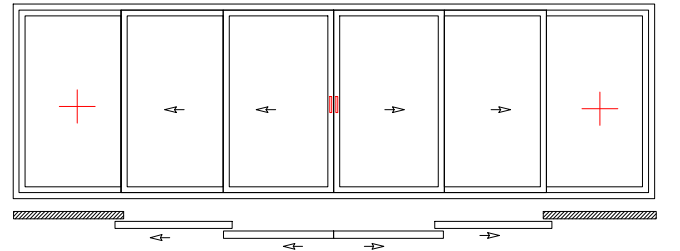
AÇILIM TİPLERİ - OPENING TYPES**2 HAREKETLİ KANAT**
2 SLIDING SASH**1 HAREKETLİ 1 SABİT KANAT**
1 SLIDING 1 FIX SASH**4 HAREKETLİ KANAT**
4 SLIDING SASH**2 HAREKETLİ 2 SABİT KANAT**
2 SLIDING 2 FIX SASH**2 HAREKETLİ 1 SABİT KANAT**
2 SLIDING 1 FIX SASH**3 HAREKETLİ KANAT**
3 SLIDING SASH**6 HAREKETLİ KANAT**
6 SLIDING SASH**4 HAREKETLİ 2 SABİT KANAT**
4 SLIDING 2 FIX SASH

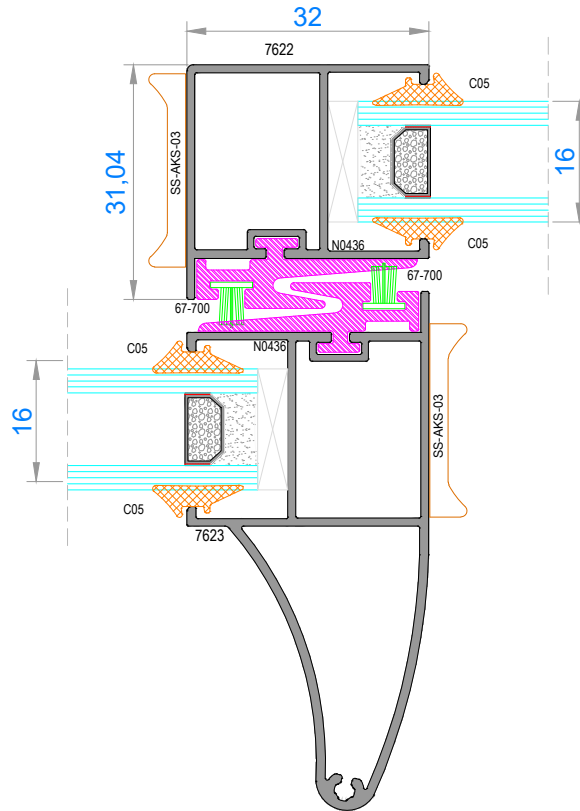
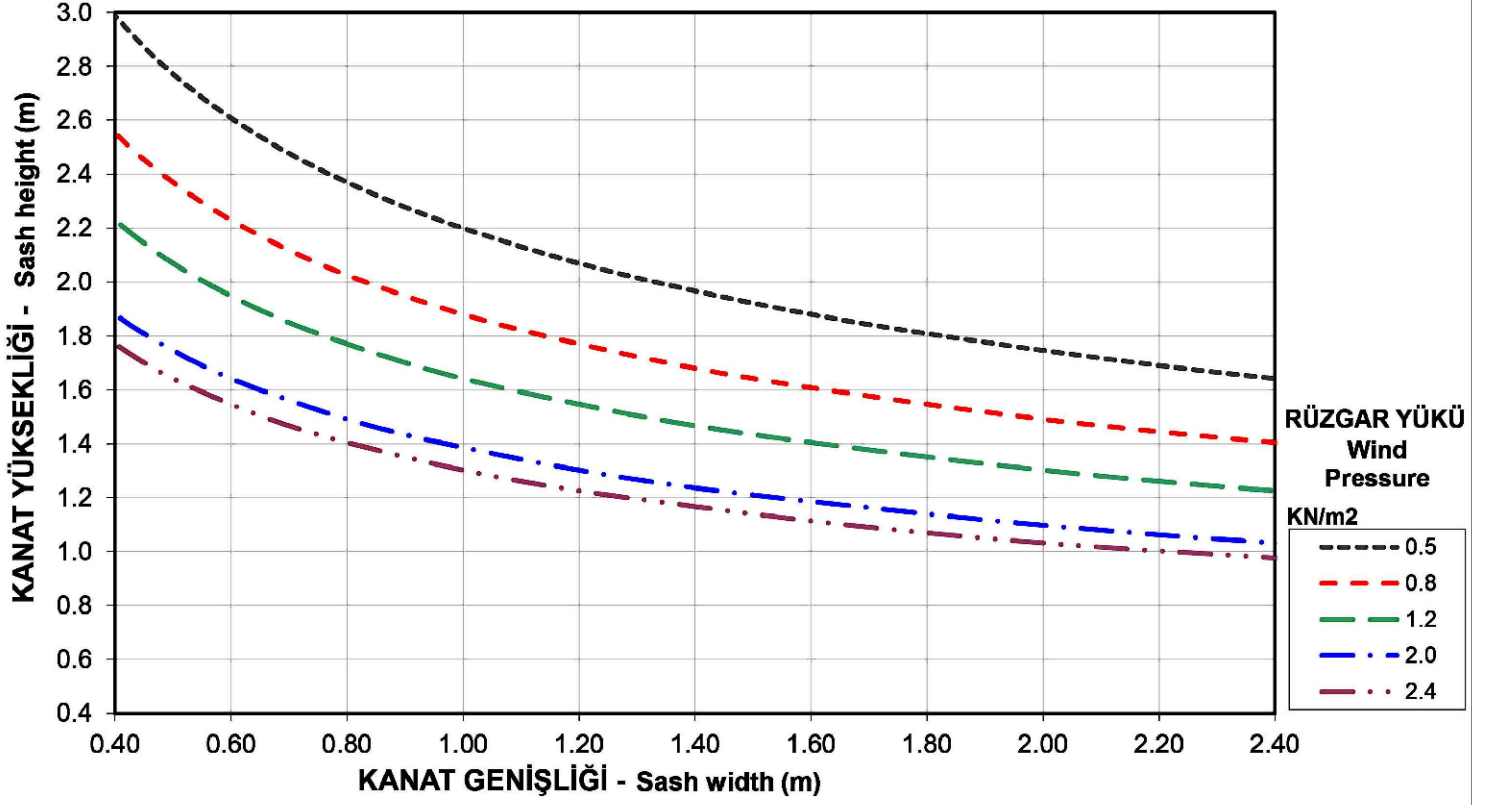
STATİK DİYAGRAMLAR - STATIC DIAGRAMS

NOT: Profil ağırlıkları teoriktir, üretim sonrası ağırlıklar geçerlidir.

KASA MONTAJ ŞEMASI - FRAME ASSEMBLY SCHEME

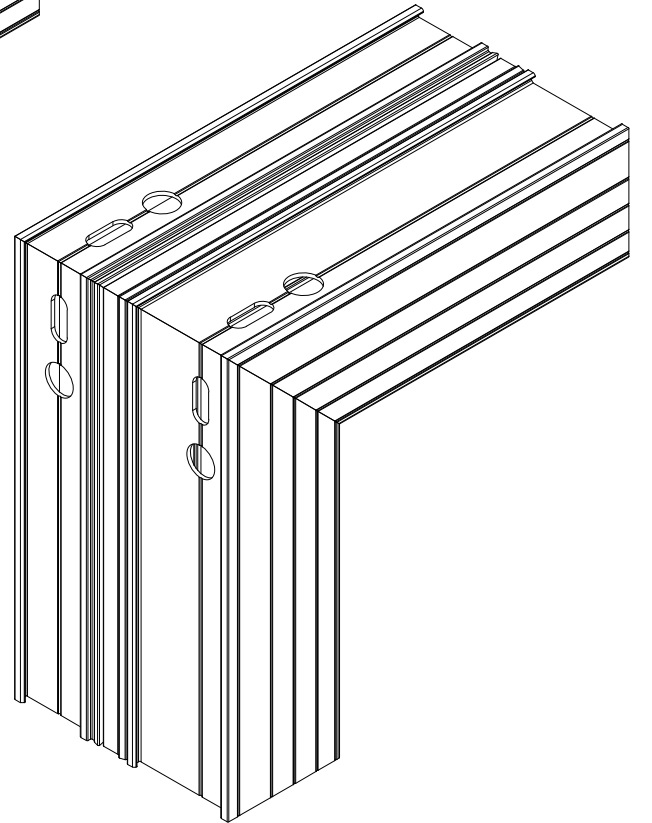
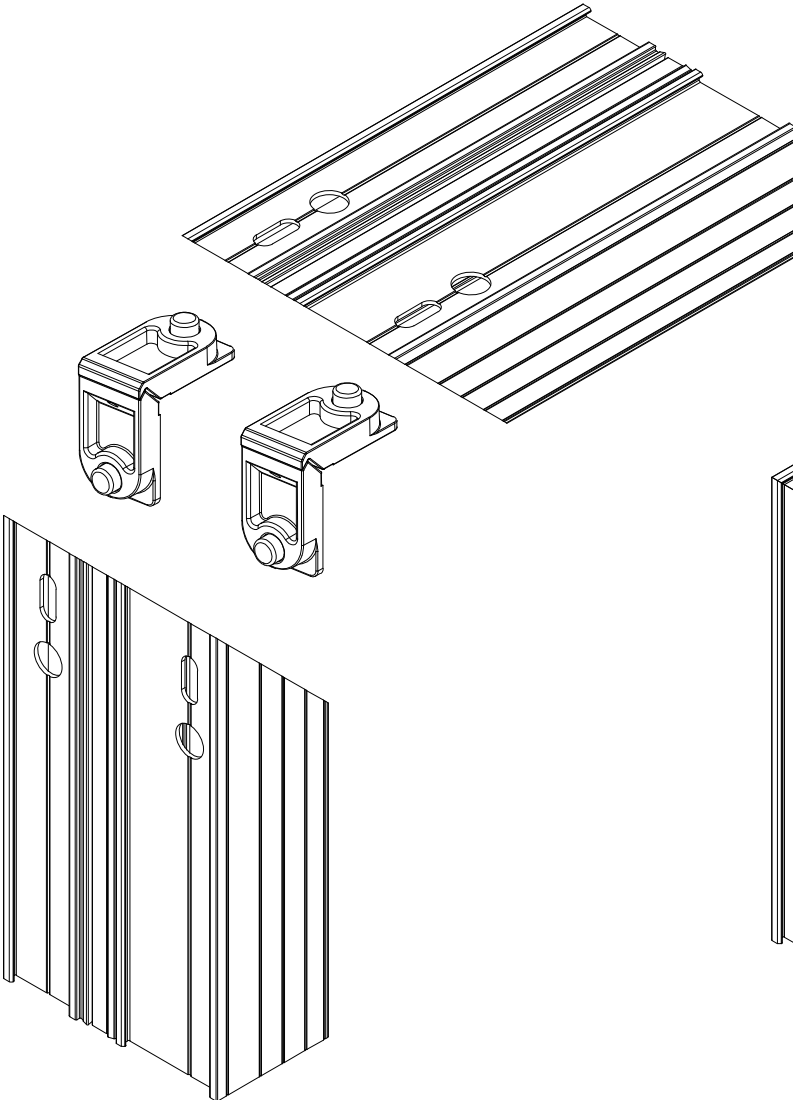
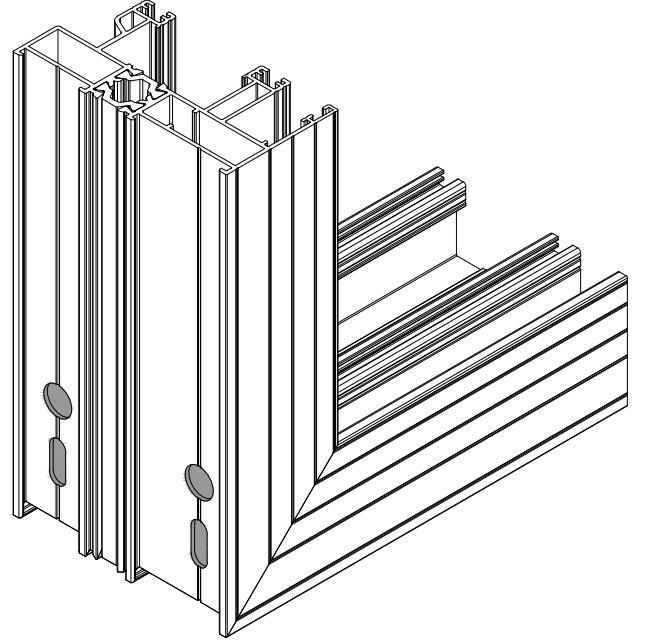
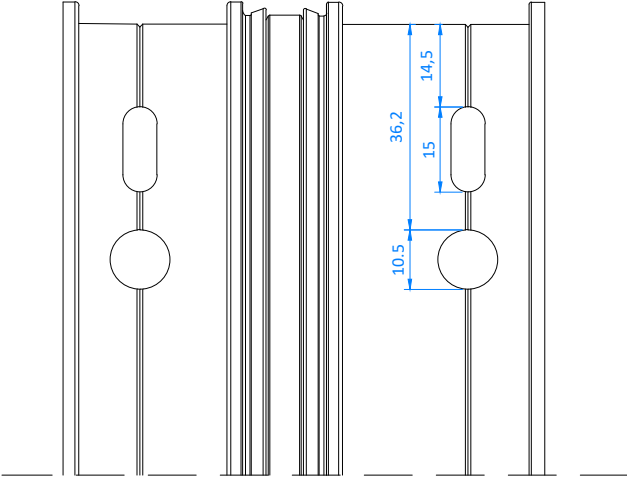

SU TAHLİYE MONTAJ ŞEMASI - WATER EMPTYING ASSEMBLY SCHEME

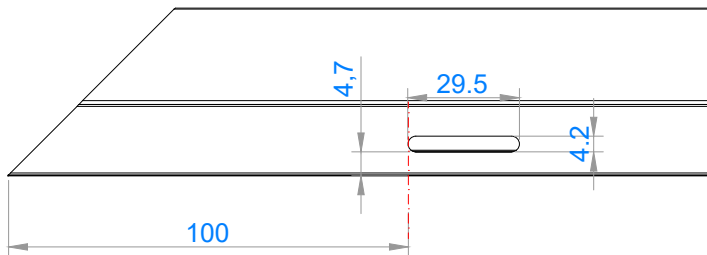
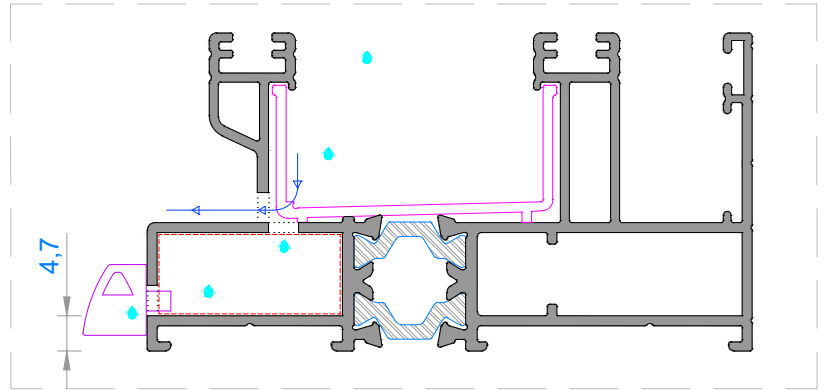
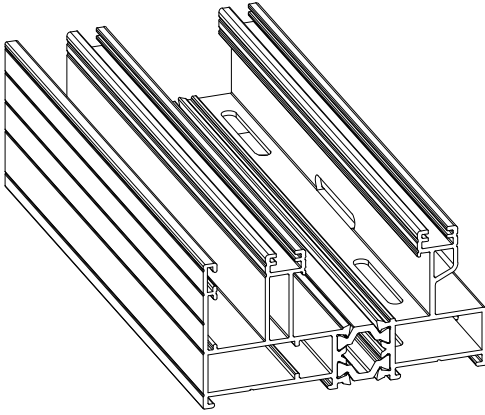
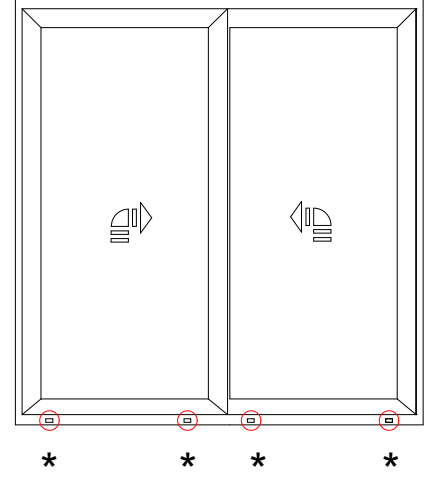
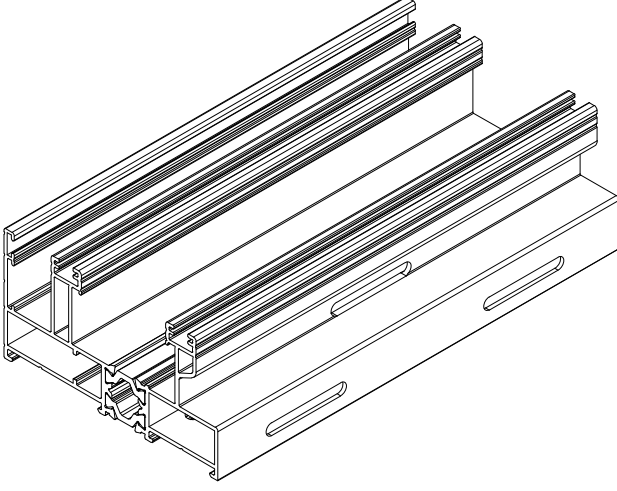

NOT: Profil ağırlıkları teoriktir, üretim sonrası ağırlıklar geçerlidir.

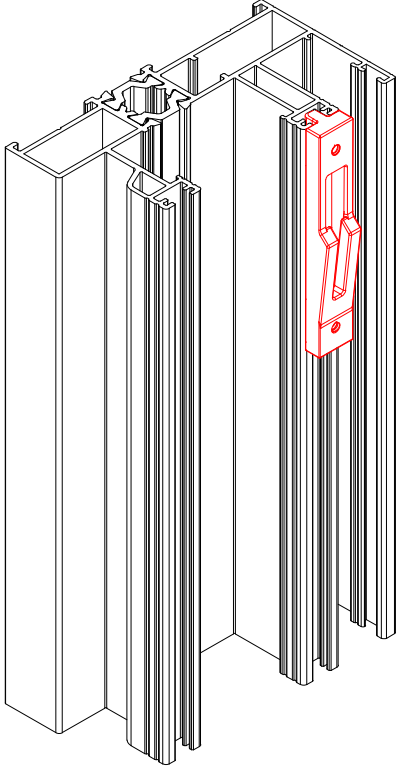
AKSESUAR MONTAJ ŞEMASI - ACCESSORY ASSEMBLY SCHEME

SS-AKS-07

Kilit karşılığı kasa profilleri köşe birleştirme işlemi yapılmadan önce yerine takılmalı.

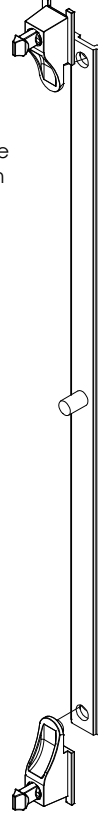

SS-AKS-06



SS-AKS-08

SS-AKS-07

SS-AKS-07

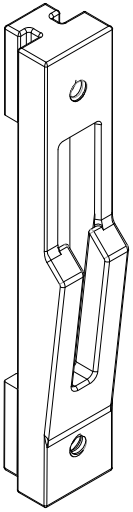

Kilit karşılığı kasa profilleri köşe birleştirme işlemi yapılmadan önce yerine takılmalı.

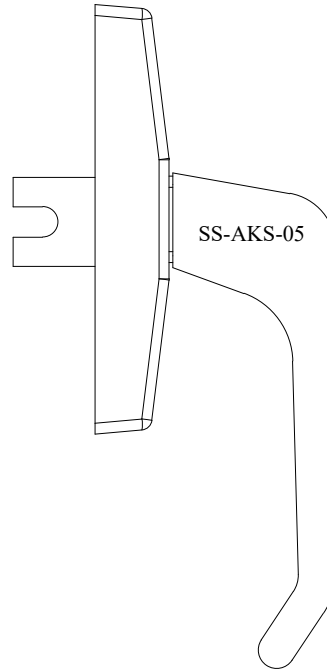

SS-AKS-05

90° KANAT MONTAJ ŞEMASI - SASH ASSEMBLY SCHEME

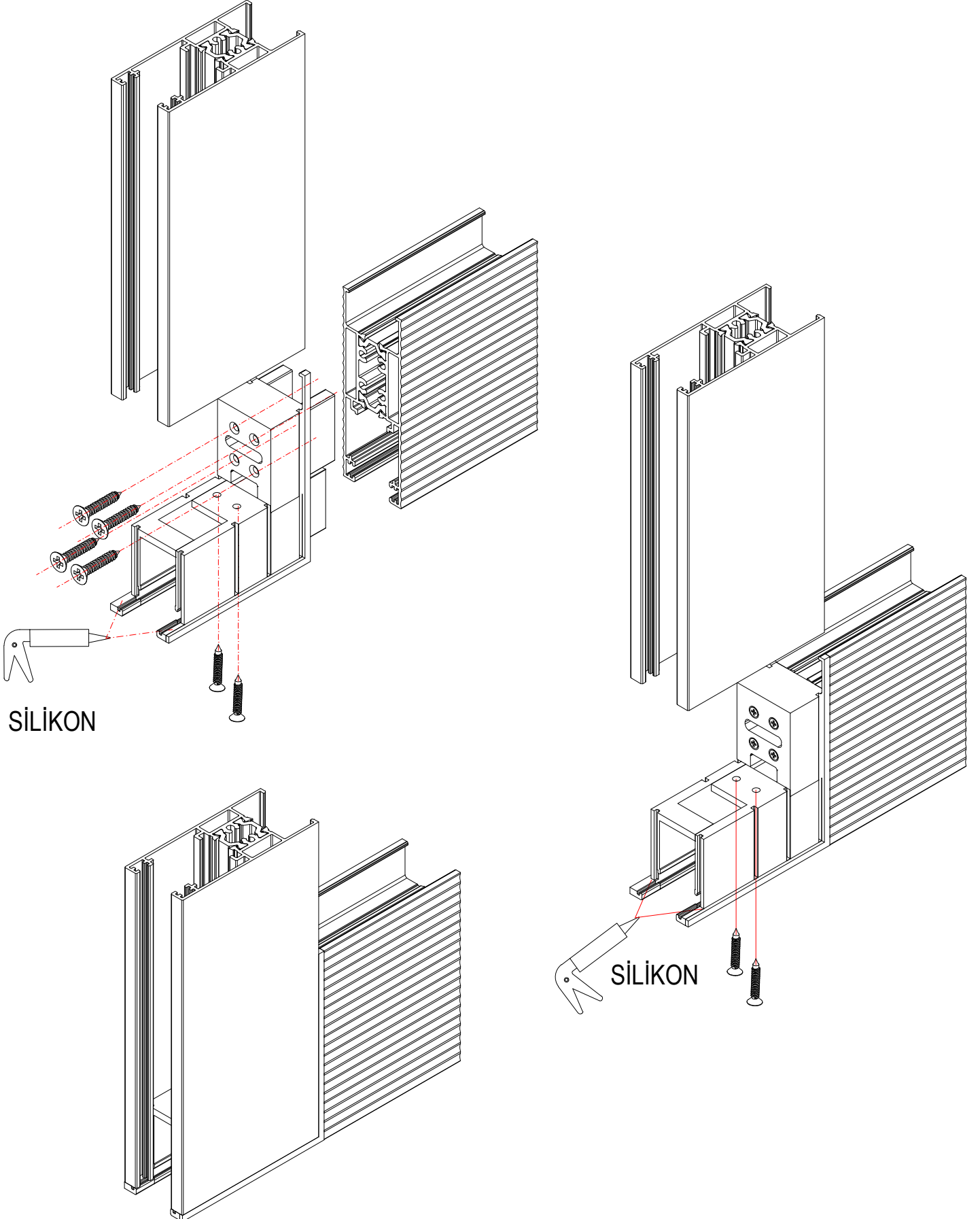

90° KANAT MONTAJ ŞEMASI - SASH ASSEMBLY SCHEME

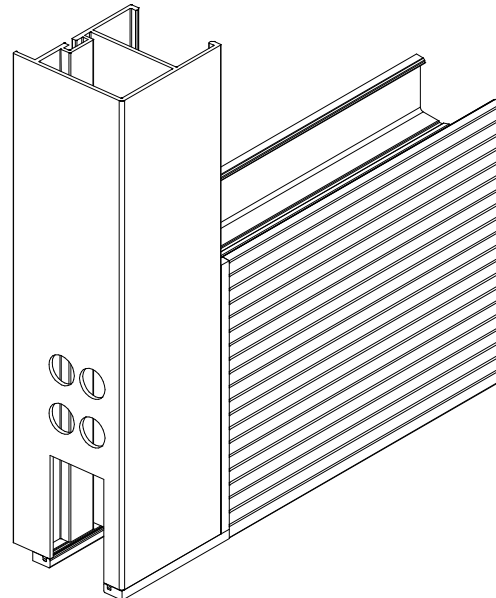
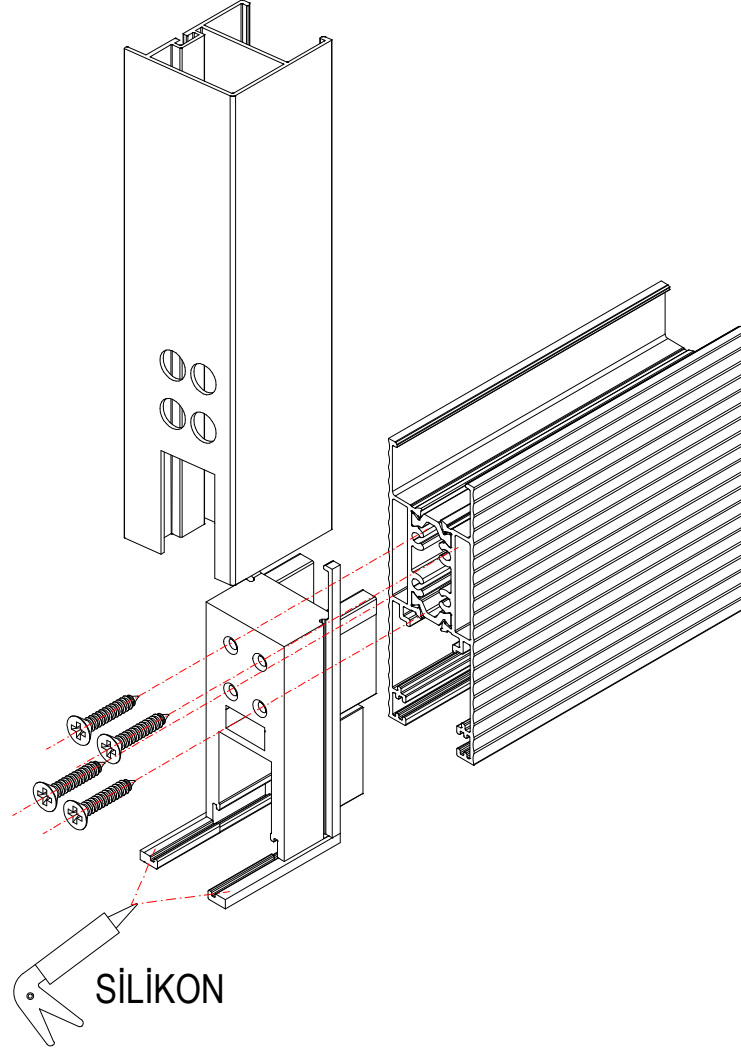

KENET KAPAĞI MONTAJ ŞEMASI - LOCKING COVER ASSEMBLY SCHEME

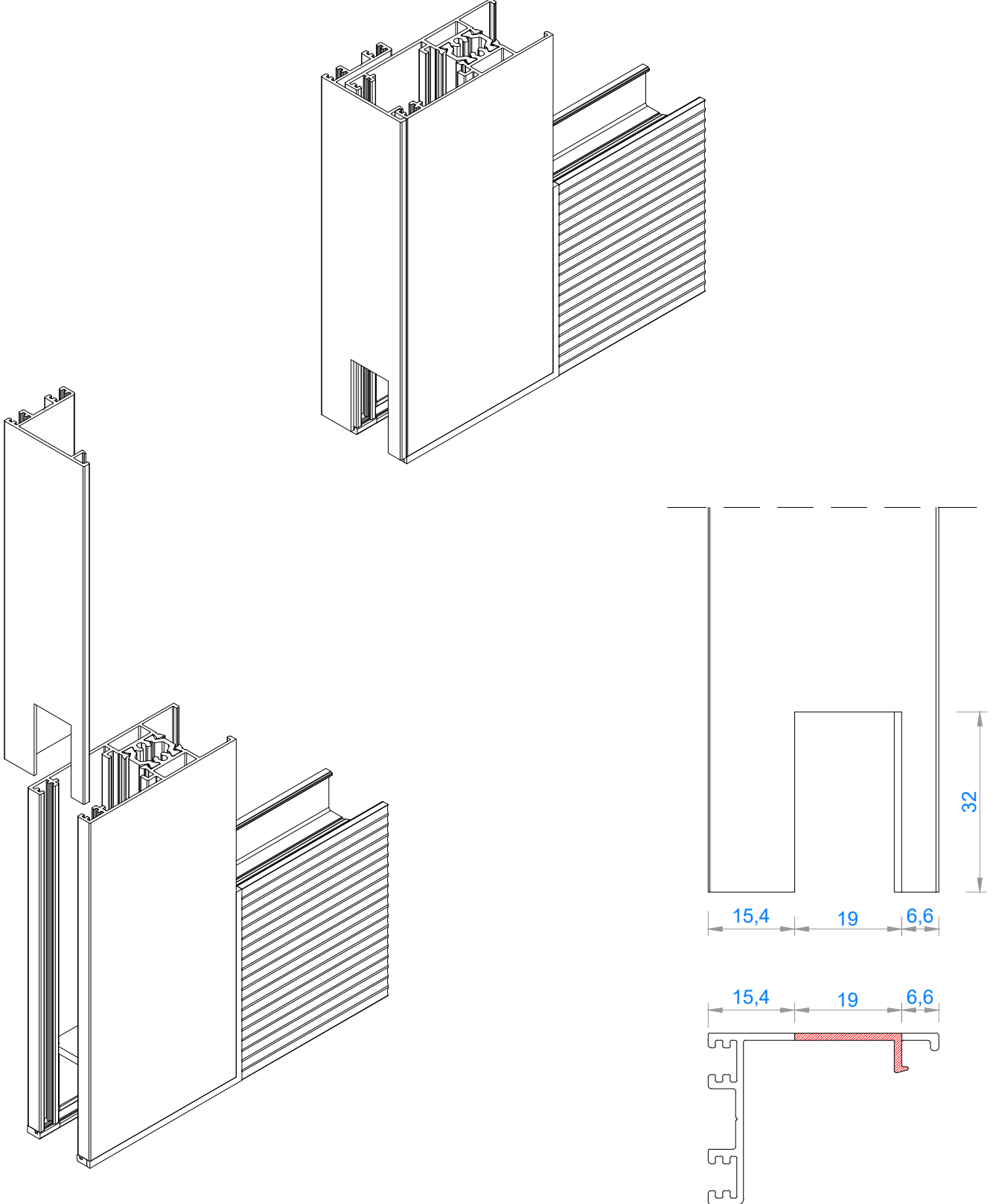

KOL MONTAJ ŞEMASI - HANDLE ASSEMBLY SCHEME

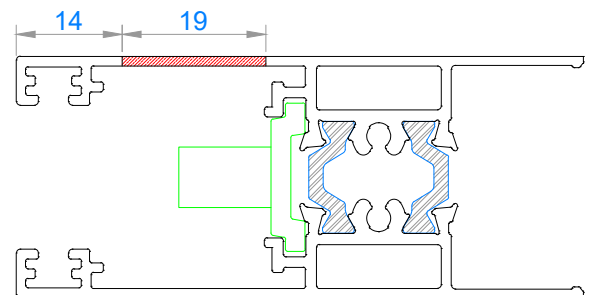
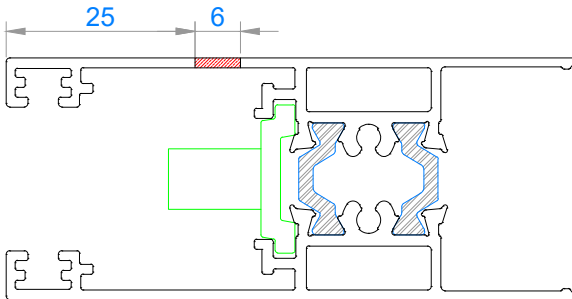
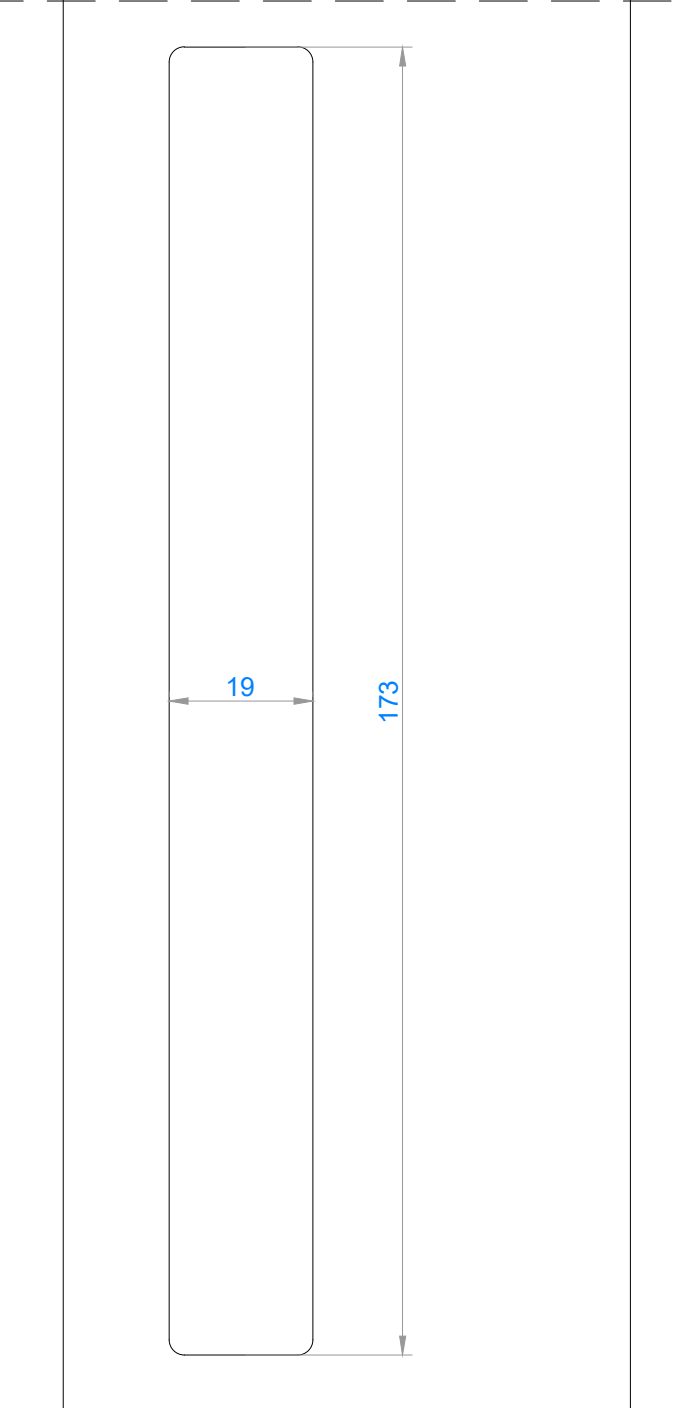
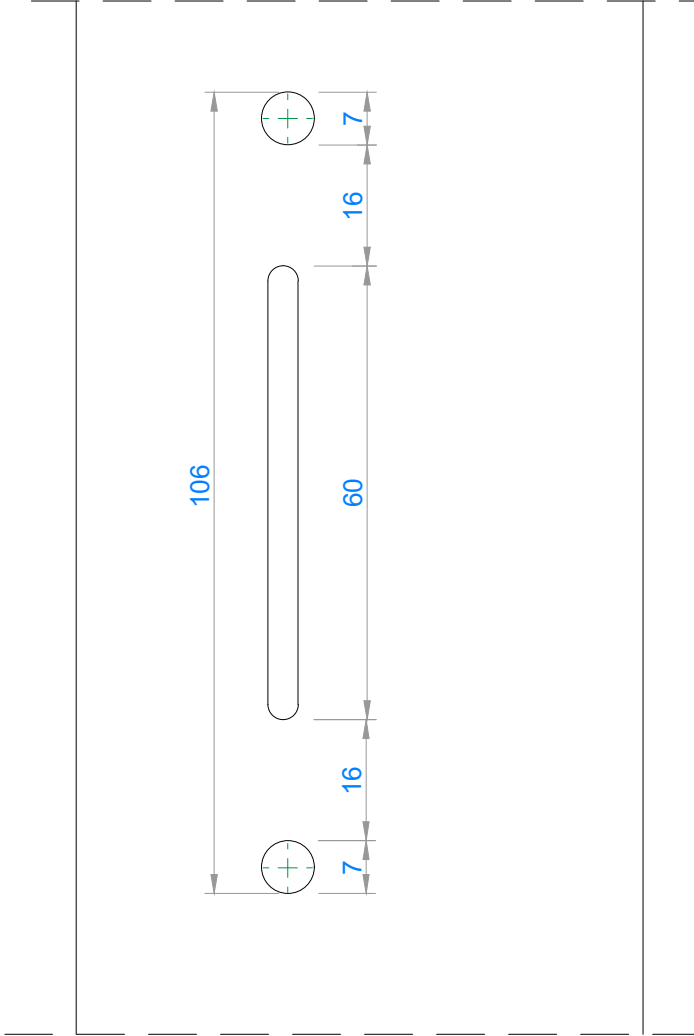

NOT: Profil ağırlıkları teoriktir, üretim sonrası ağırlıklar geçerlidir.

KENET MONTAJ ŞEMASI - LOCKING ASSEMBLY SCHEME

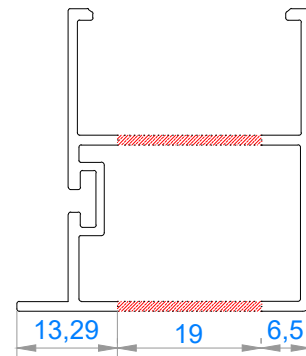
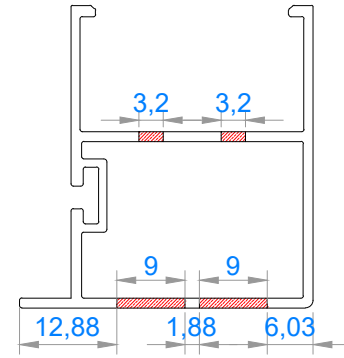
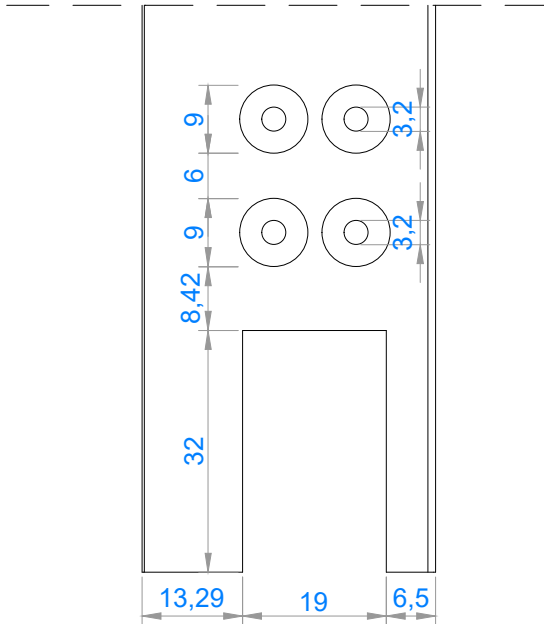
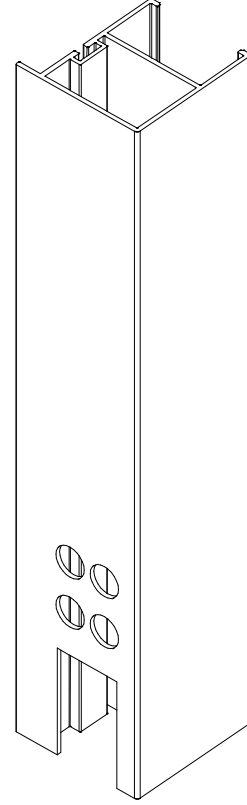
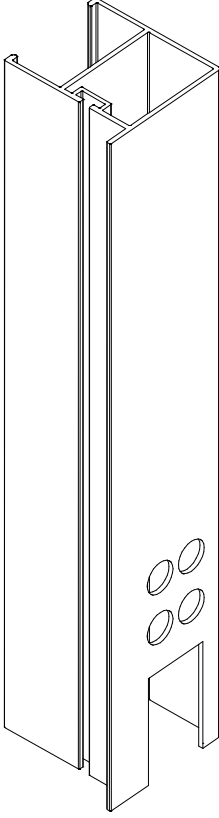

KENET MONTAJ ŞEMASI - LOCKING ASSEMBLY SCHEME

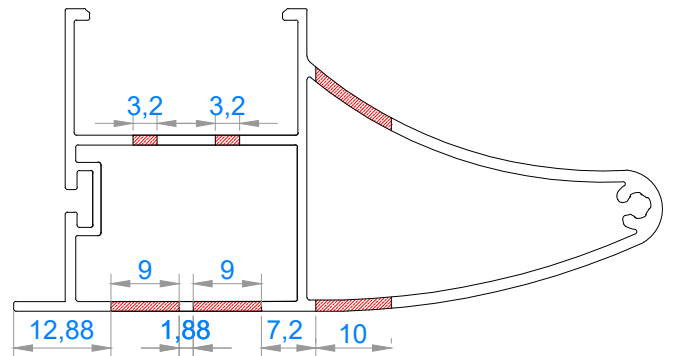
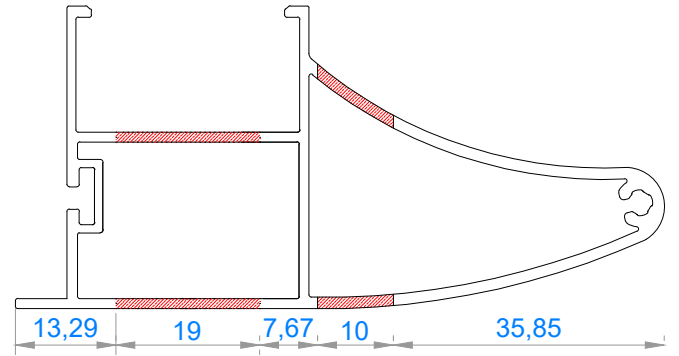
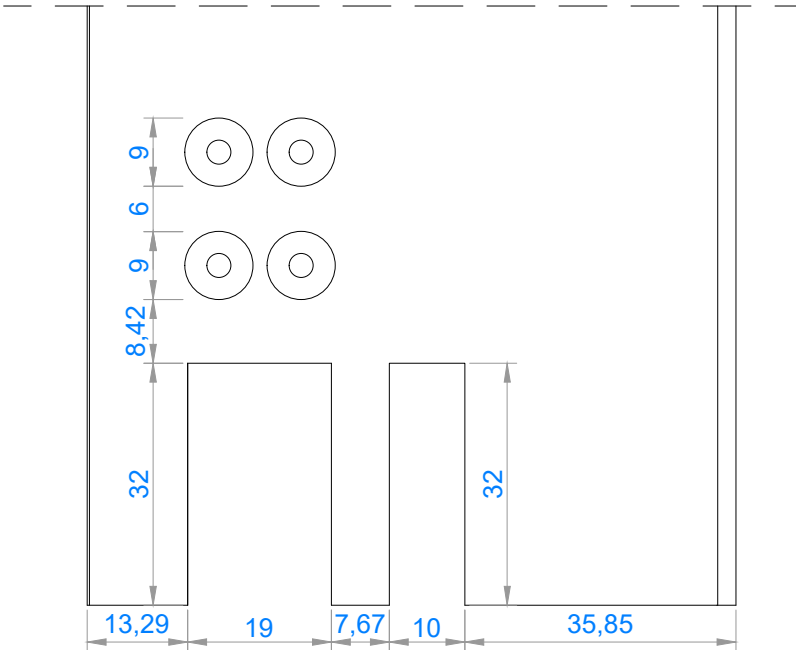
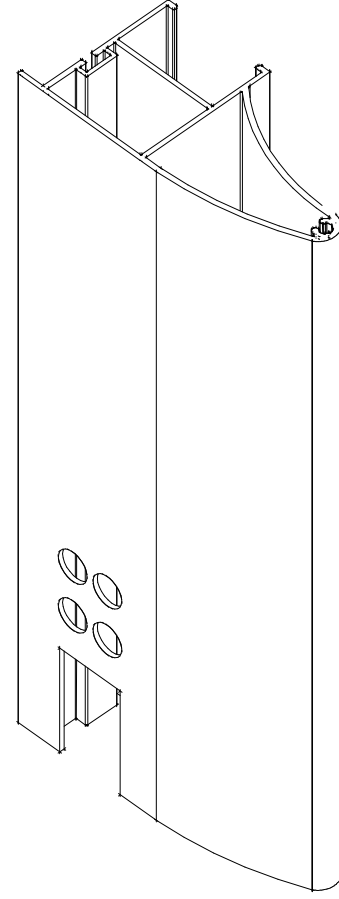
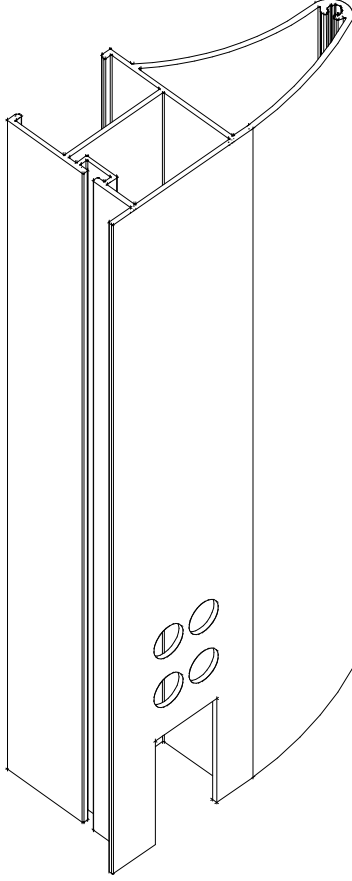

PVC İSPANYOLET MONTAJI - PVC LOCKING ASSEMBLY SCHEME

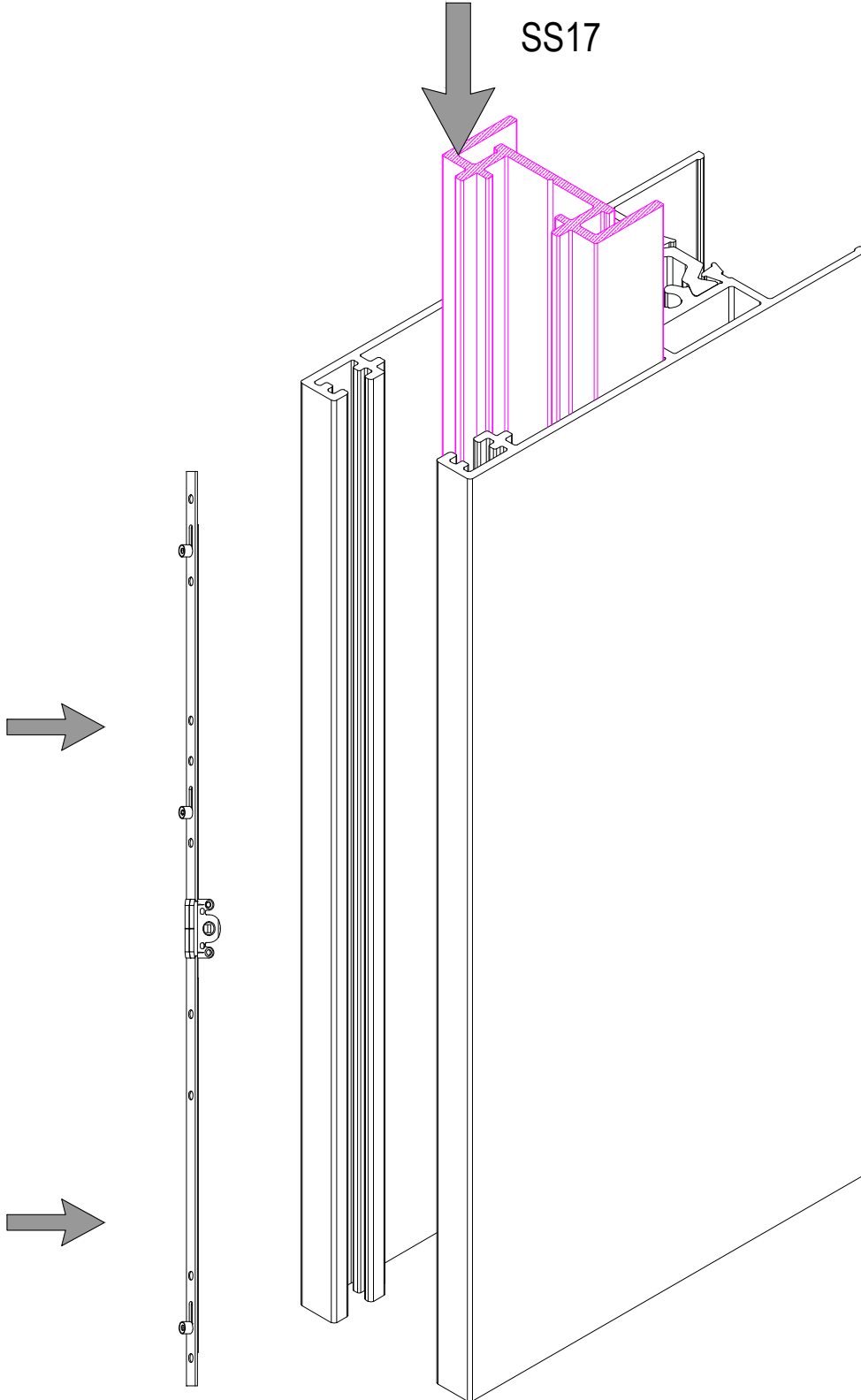

NOT: Profil ağırlıkları teoriktir, üretim sonrası ağırlıklar geçerlidir.

KENET MONTAJ ŞEMASI - LOCKING ASSEMBLY SCHEME

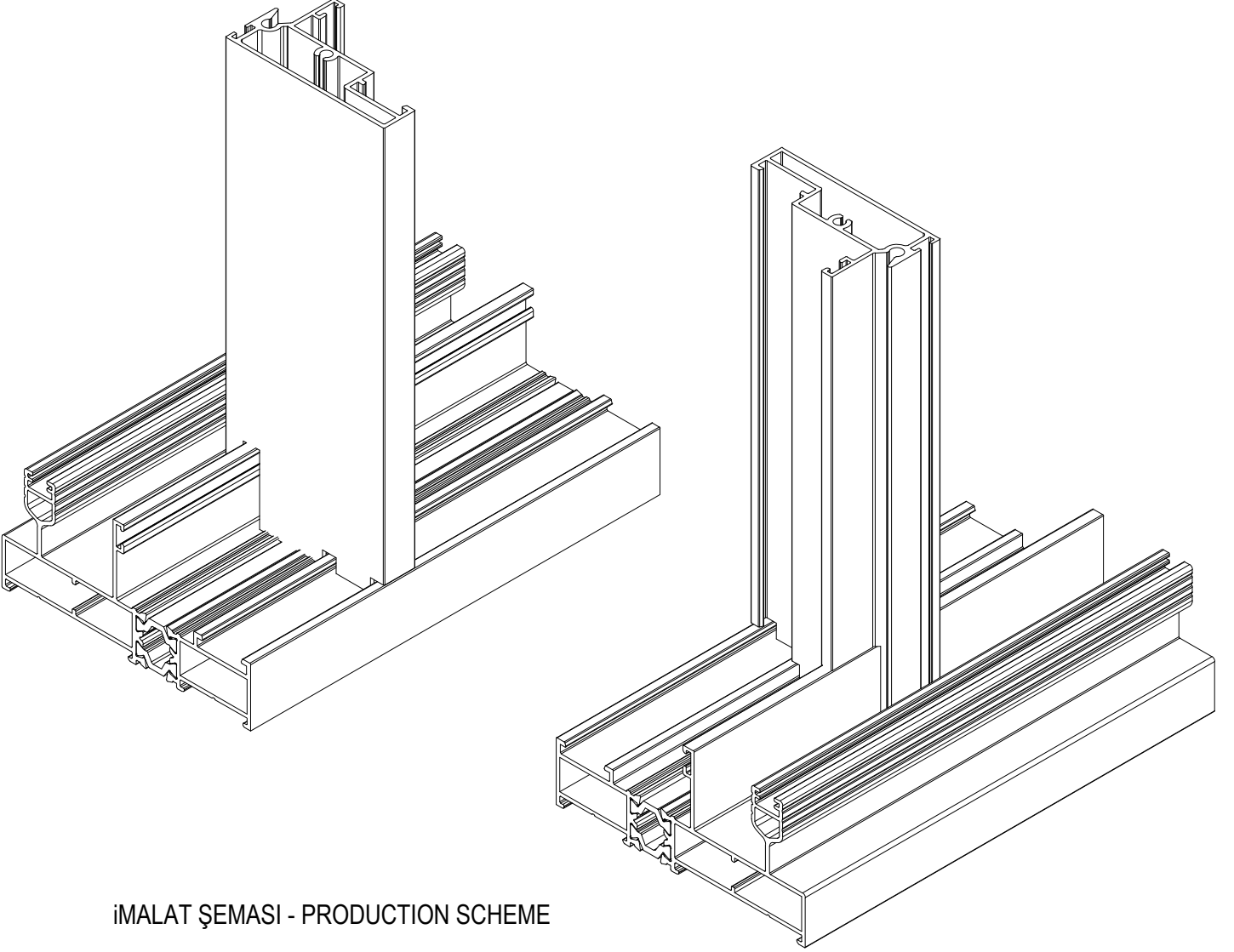

İMALAT ŞEMASI - PRODUCTION SCHEME

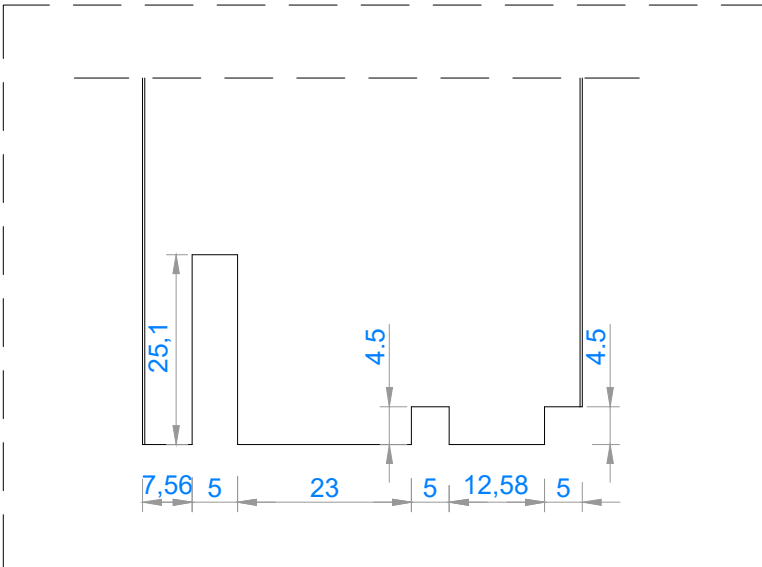

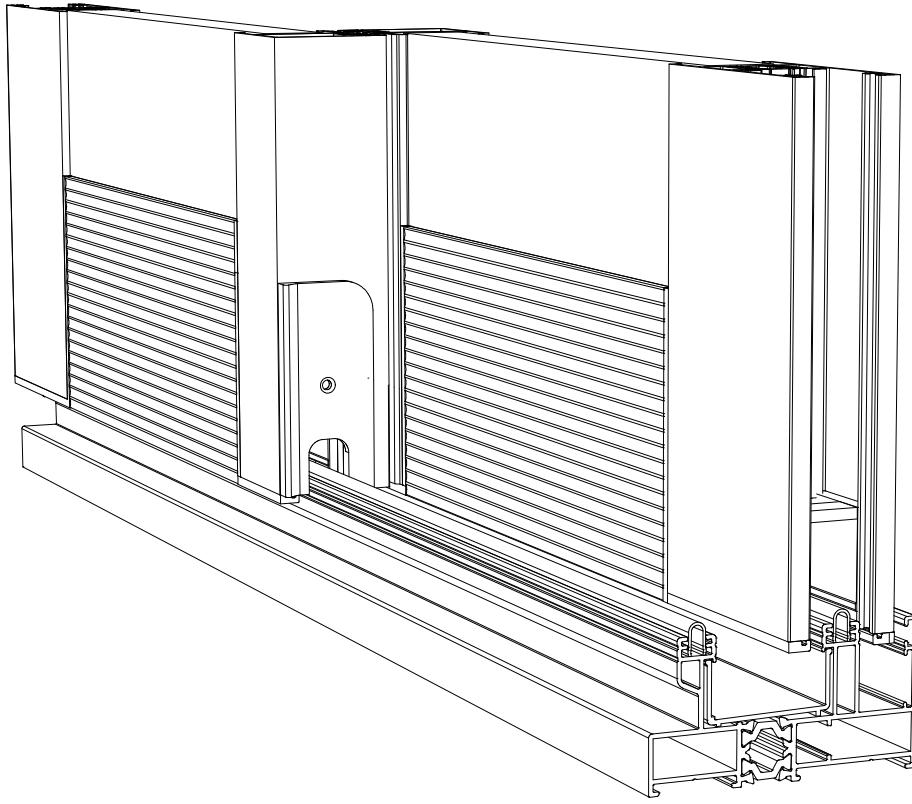









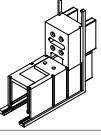
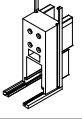
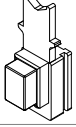

FAUSTO MİMARİ SİSTEMLER

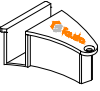
32ST AKSESUARLAR

32ST ACCESSORIES

AKSESUAR RESMİ	AKSESUAR KODU	MALZEME	MALZEME TANIMI	AMBALAJ	BİRİM FİYAT
	C01	EPDM	4'LÜ SÜRME ADAPTÖR CONTASI	10 KG/160 MT	
	C02	EPDM	KANAL KAPAMA CONTASI	10 KG/250 MT	
	C03	EPDM	KASA KAPAMA CONTASI	12 KG/160 MT	
	C05	EPDM	İÇ-DİŞ CAM CONTASI	12 KG/265 MT	
	SS-AKS-01	INOX	ÇELİK RAY	1 BOY/6 MT	
	SS-AKS-02	EPDM	SIZDIRMAZLIK PARÇASI	40 AD/ 1 PKT	
	SS-AKS-04	INOX	RULMAN	140 AD/ 1 KOLİ	
	SS-AKS-09	INOX	RULMAN-SİNEKLİK	200 AD/ 1 KOLİ	
	SS-AKS-07	INOX	KİLİT-KARŞILIK	100 TKM/ 1 KOLİ	
	SS-AKS-05	SB	EKSENEL KOL	32 ADET/KOLİ	
		RENKLİ		32 ADET/KOLİ	
		ELOKSAL		32 ADET/KOLİ	
	SS-AKS-08	SB	HAVUZ KOL	32 ADET/KOLİ	
		RENKLİ		32 ADET/KOLİ	
		ELOKSAL		32 ADET/KOLİ	
	LC-1125	INOX	ALYAN KÖŞE	250 AD/ 1 KOLİ	
	KİL FİTİL	NAYLON	$\frac{67}{500}$ $\frac{67}{700}$ KİL FİTİL	4X300MT/KG	

NOT: Profil ağırlıkları teoriktir, üretim sonrası ağırlıklar geçerlidir.

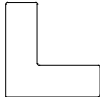
AKSESUAR RESMİ	AKSESUAR KODU	MALZEME	MALZEME TANIMI	AMBALAJ	BİRİM FİYAT
	SS-AKS-10	PVC	90° KANAT KÖŞE TAKOZU	150 AD/ 1 KOLİ	
	SS-AKS-11	PVC	90° KENET KÖŞE TAKOZU	300 AD/ 1 KOLİ	
	SS-AKS-13	PVC	STOPER	500 AD/ 1 KOLİ	
	SS-AKS-03	PVC	DÜZ KENET KAPAK	500 TKM/ 1 KOLİ	
	SS-AKS-14	PVC	TAKVİYELİ KENET KAPAK	500 TKM/ 1 KOLİ	
	B4435	PVC	KASA U PLASTİĞİ	1 BOY/6 MT	
	N0436	PVC	KENET KİTLEME PLASTİĞİ (90°)	1 BOY/6 MT	
	B8802	PVC	KENET KİTLEME PLASTİĞİ (45°)	1 BOY/6 MT	
	SS-AKS-06P	PVC	PENCERE TİJ (75 CM)	ADET	
	SS-AKS-06K	PVC	KAPI TİJ (150 CM)	ADET	
	7 MM X 1 MM	INOX	KÖŞE GÖNYESİ	ADET	
	15 MM X 1,2 MM	INOX	KÖŞE GÖNYESİ	ADET	
	28 MM X 1,5 MM	INOX	KÖŞE GÖNYESİ	ADET	

NOT: Profil ağırlıkları teoriktir, üretim sonrası ağırlıklar geçerlidir.