

## FAUSTO CAMLAMA SİSTEMLERİ

100S SÜRME CAM BALKON  
100S SLIDING GLASS BALCONY

Sistem Kodu **50100**Ağırlık (kg/mt) **1,445**Sistem Kodu **50102**Ağırlık (kg/mt) **1,553**Sistem Kodu **50101**Ağırlık (kg/mt) **0,933**Sistem Kodu **50103**Ağırlık (kg/mt) **0,949**

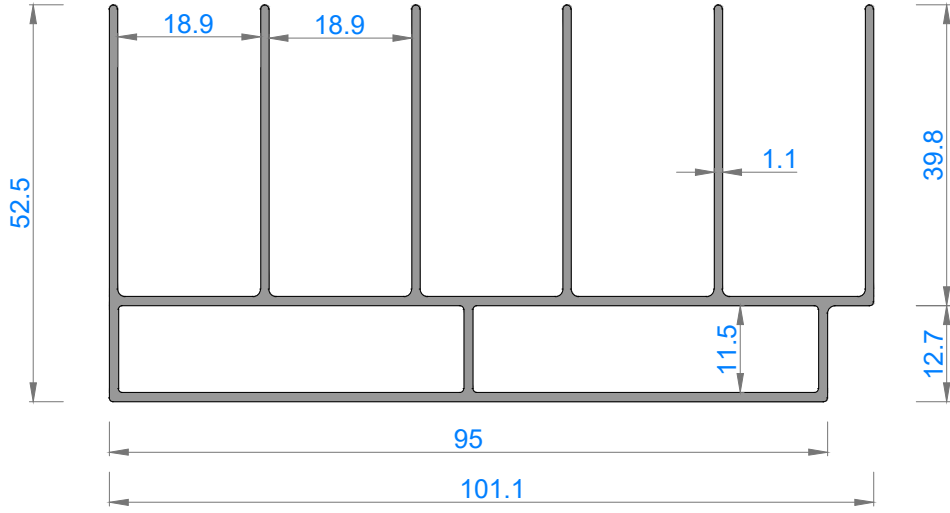
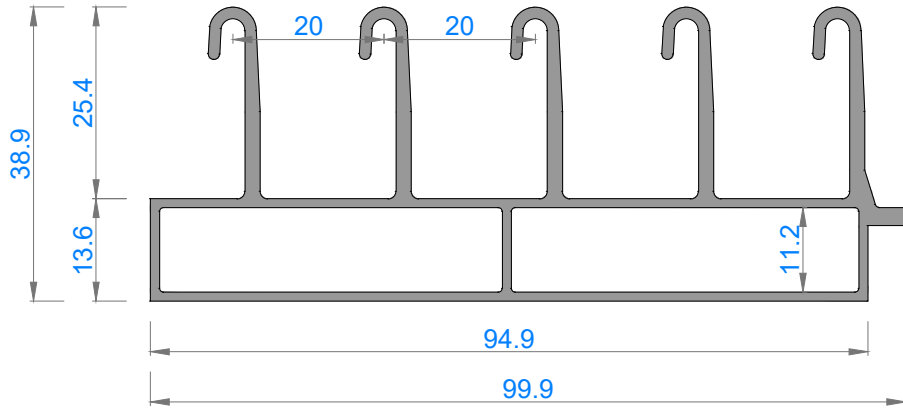
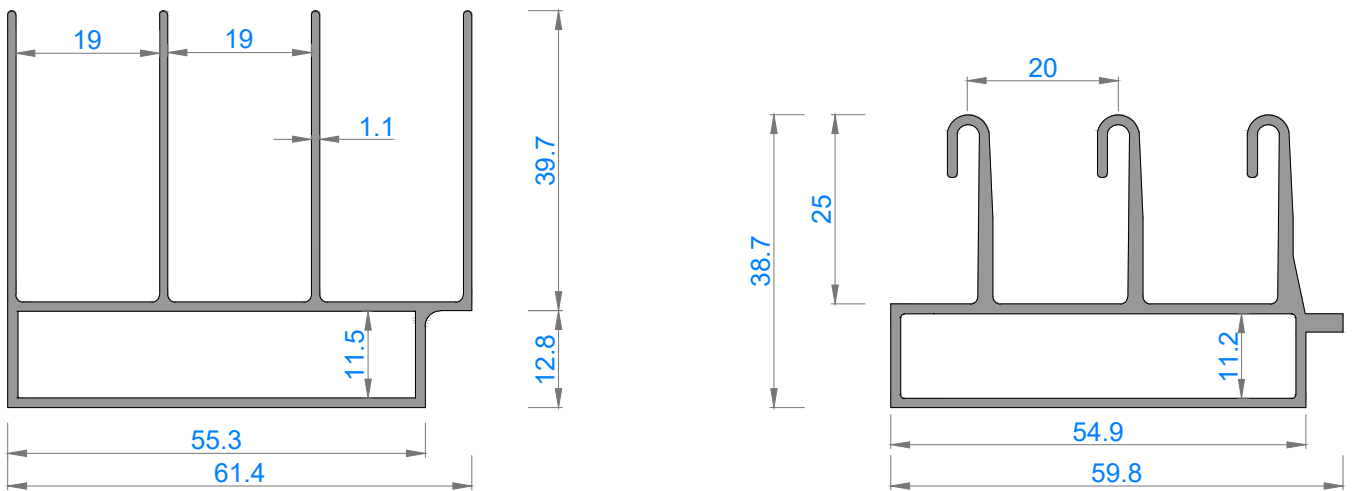
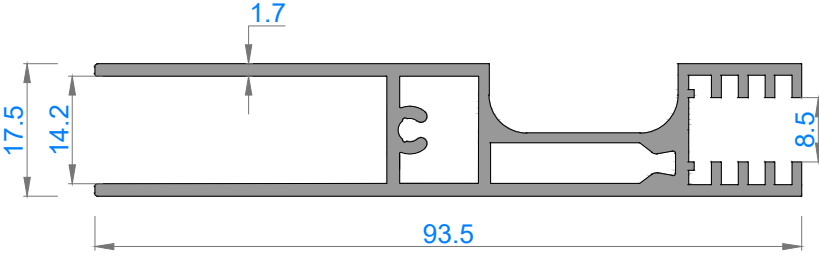

Sistem Kodu **50104**  
Ağırlık (kg/mt) **1,158**

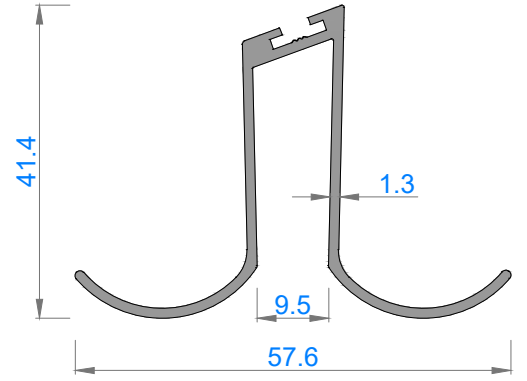

Sistem Kodu **50105**  
Ağırlık (kg/mt) **0,494**

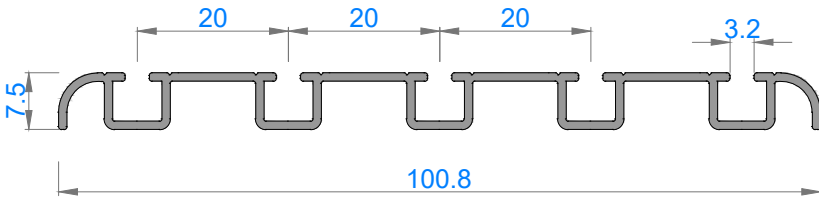

Sistem Kodu **50106**  
Ağırlık (kg/mt) **0,552**

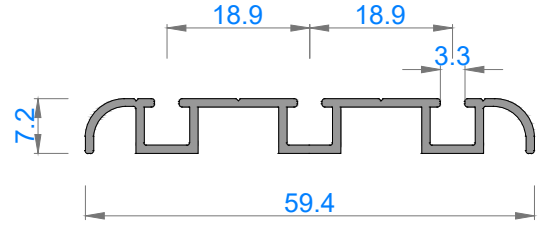

Sistem Kodu **50107**  
Ağırlık (kg/mt) **0,333**

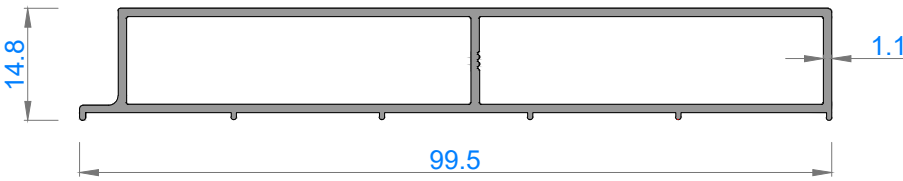

Sistem Kodu **50108**  
Ağırlık (kg/mt) **0,691**

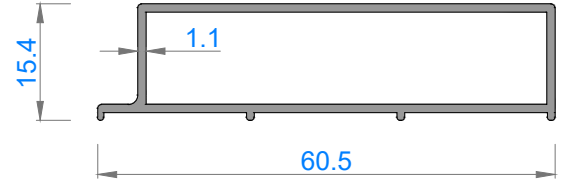

Sistem Kodu **50109**  
Ağırlık (kg/mt) **0,428**

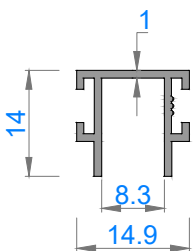

Sistem Kodu **50110**  
Ağırlık (kg/mt) **0,138**

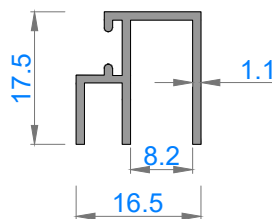

Sistem Kodu **50111**  
Ağırlık (kg/mt) **0,185**

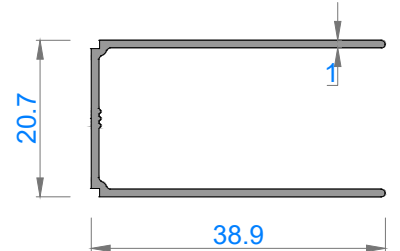

Sistem Kodu **50112**  
Ağırlık (kg/mt) **0,261**

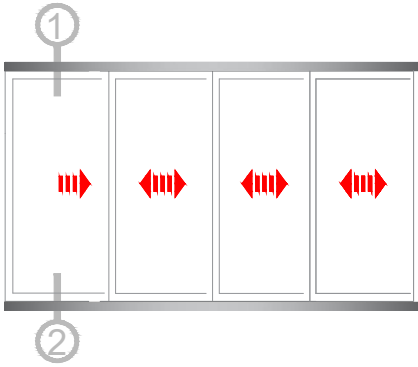

D-1

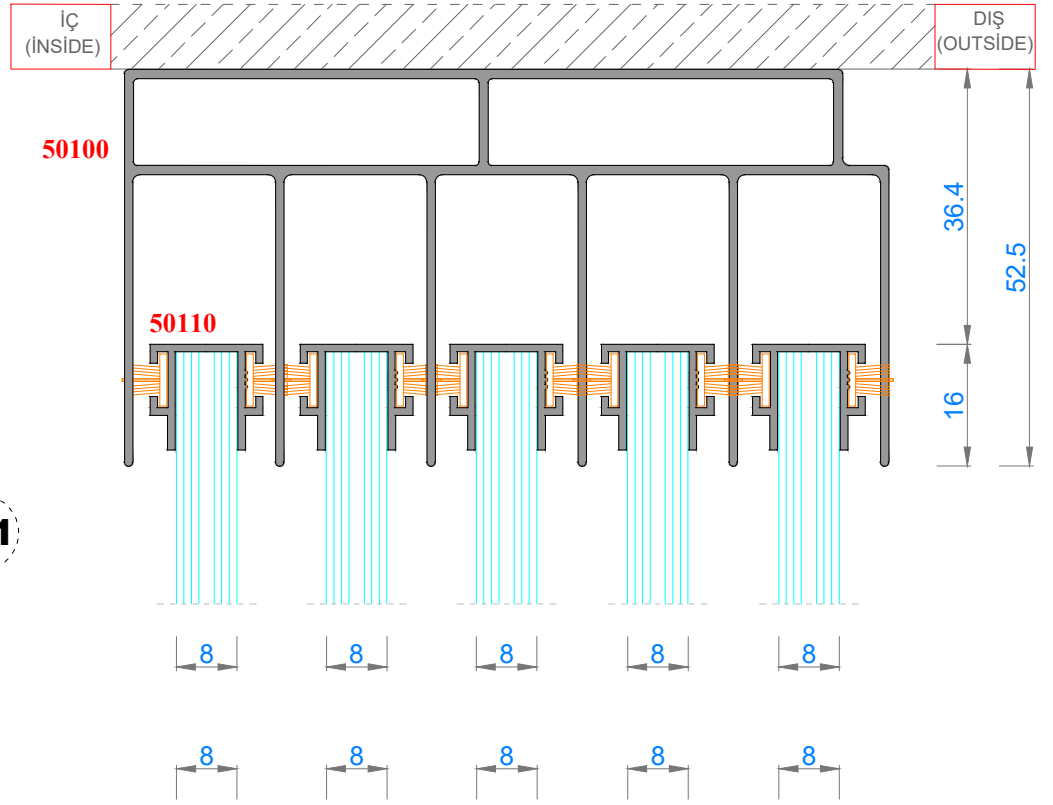

D-2

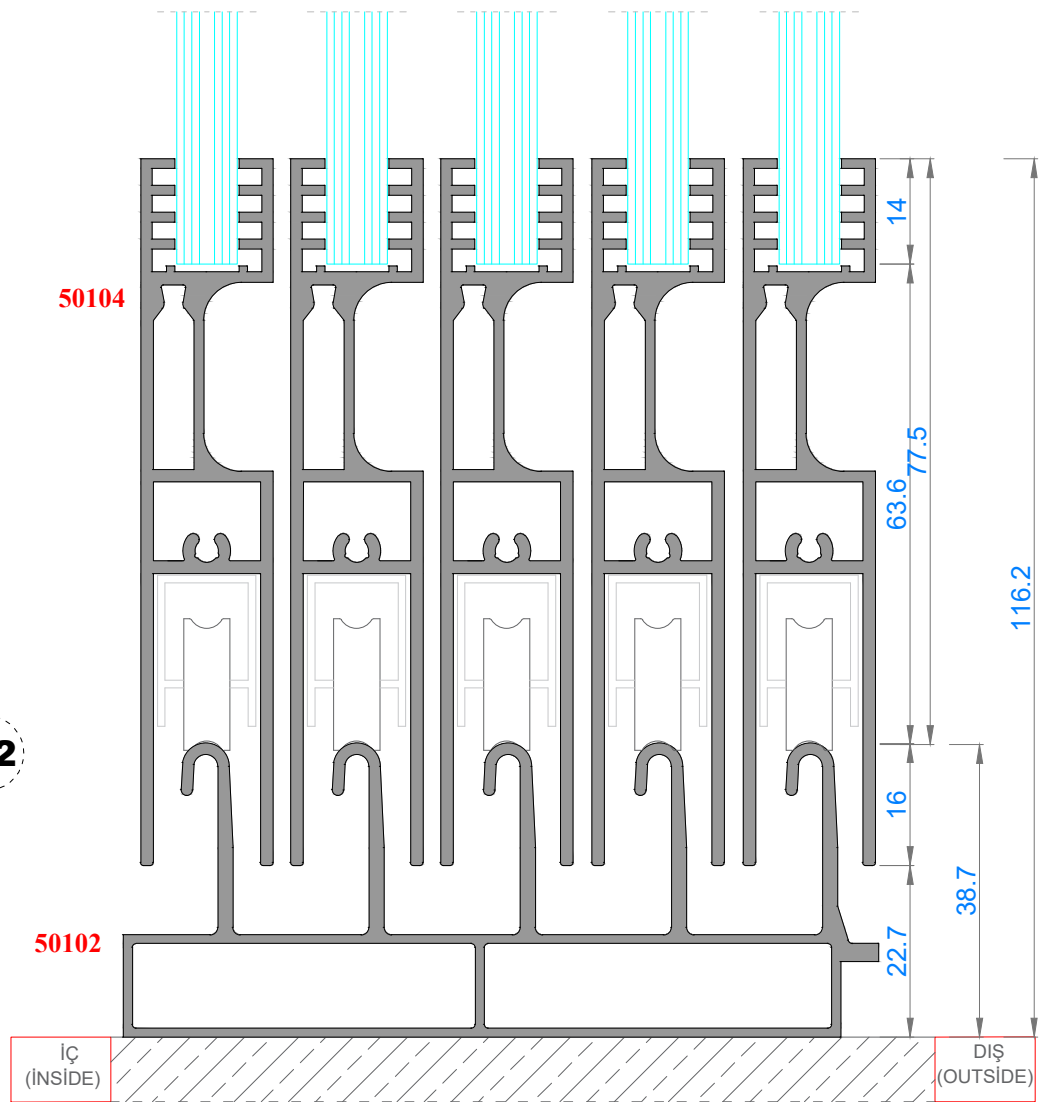

NOT: Profil ağırlıkları teoriktir, üretim sonrası ağırlıklar geçerlidir.

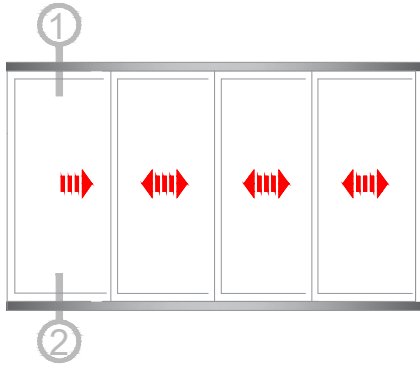

**D-1**

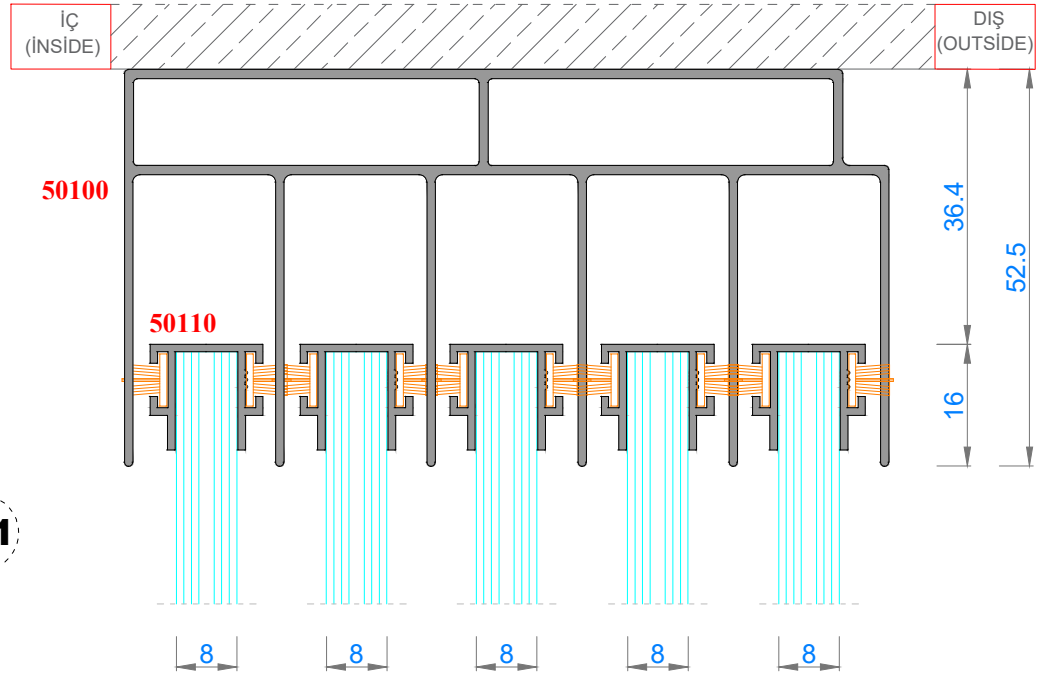

**D-2**

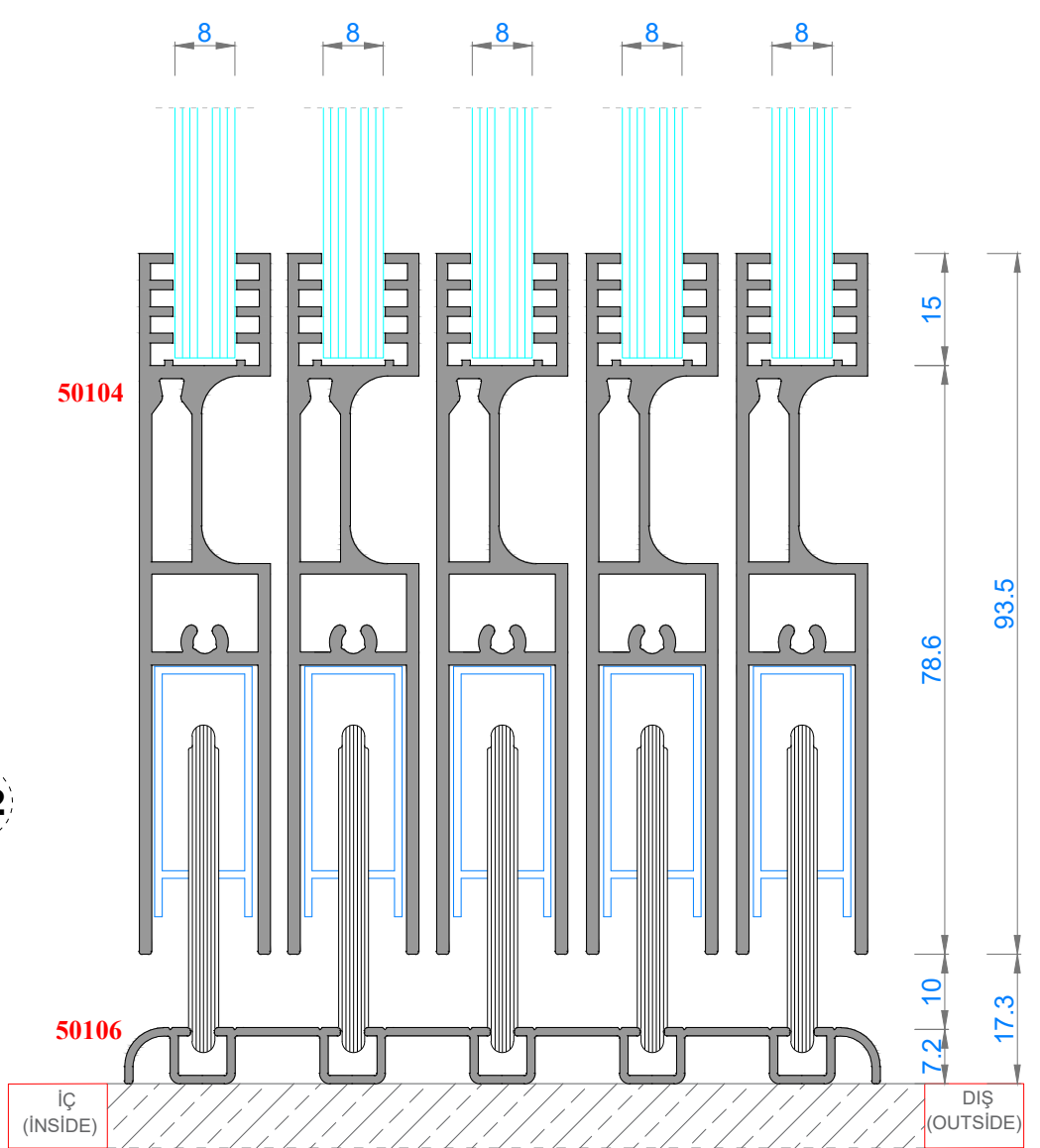

NOT: Profil ağırlıkları teoriktir, üretim sonrası ağırlıklar geçerlidir.

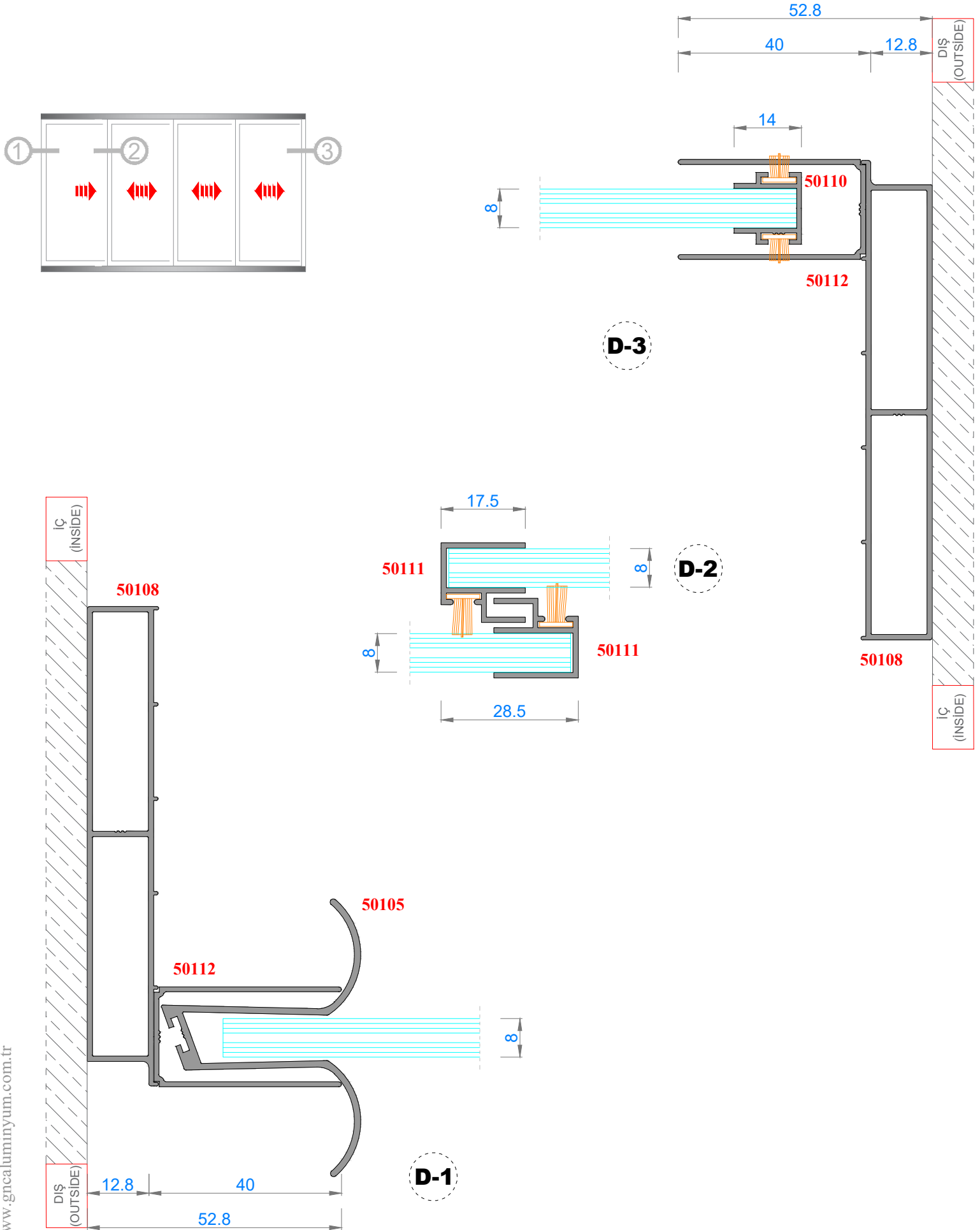

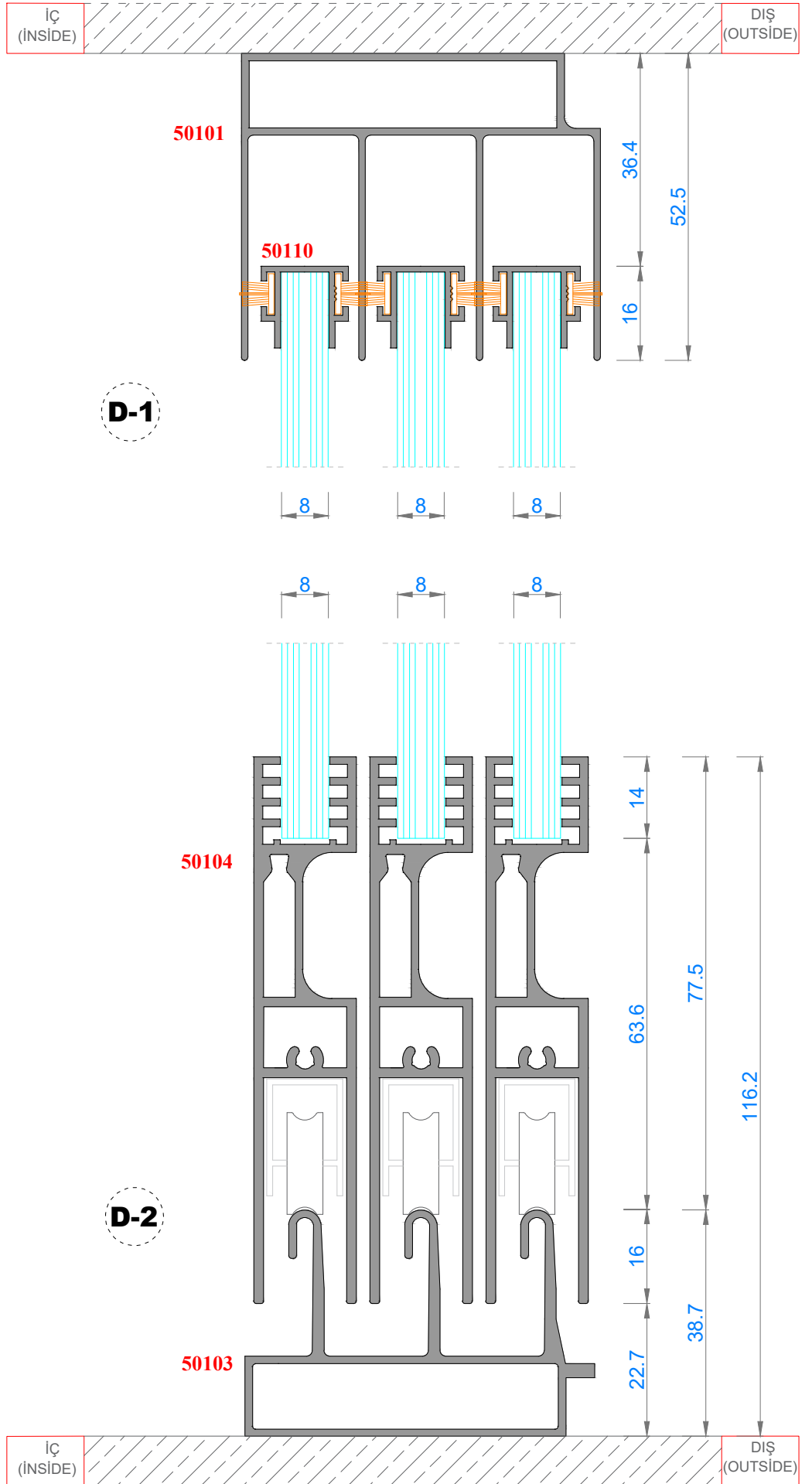
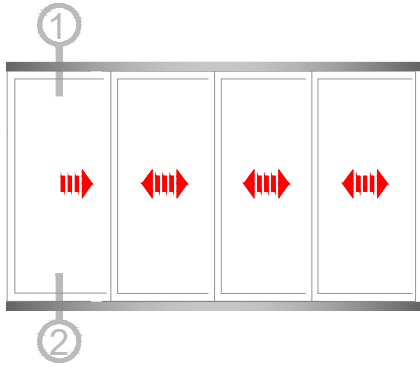

NOT: Profil ağırlıkları teoriktir, üretim sonrası ağırlıklar geçerlidir.

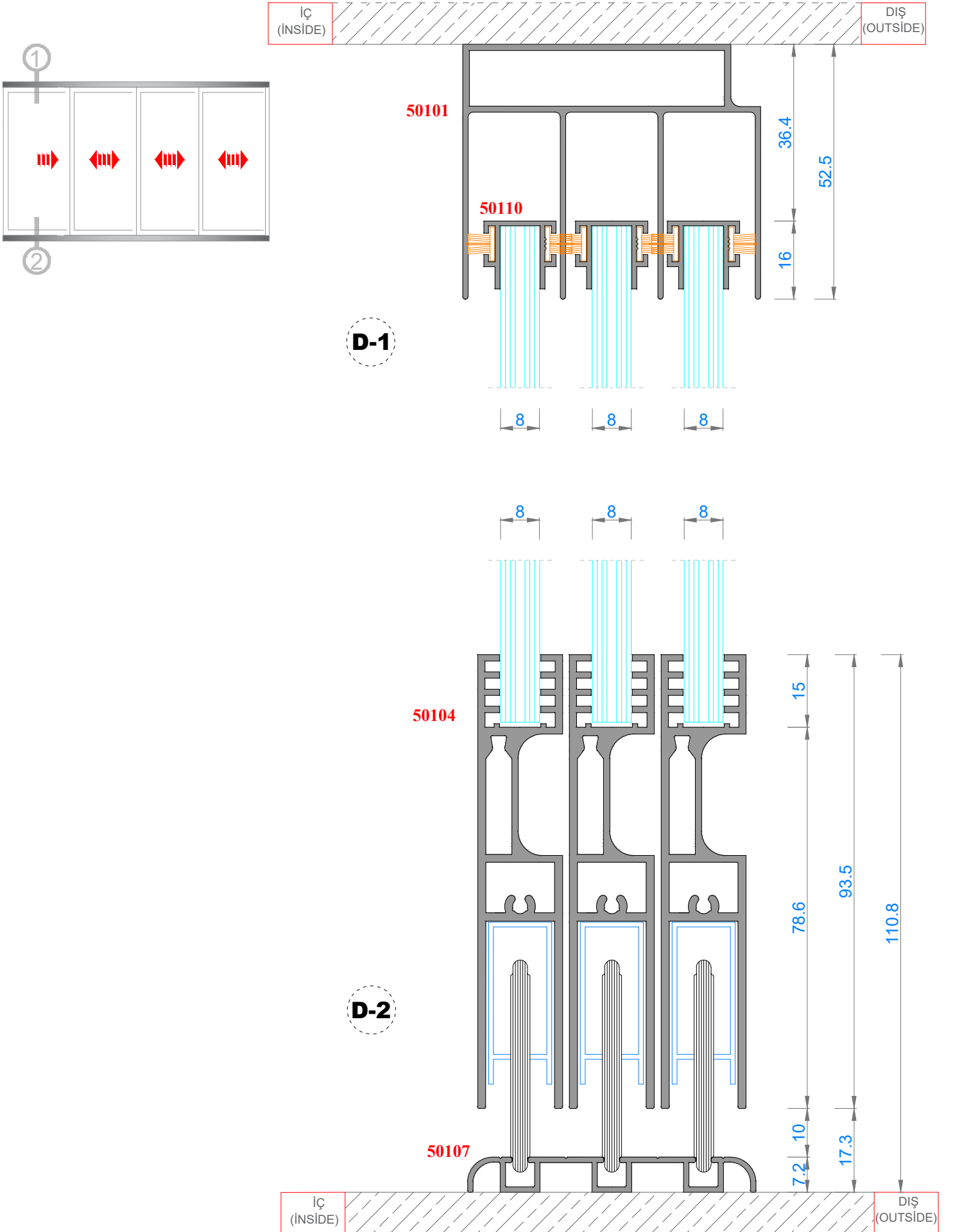

NOT: Profil ağırlıkları teoriktir, üretim sonrası ağırlıklar geçerlidir.



